

1610

July  
1984

# elektor

INDIA

Rs. 7.50

# electronics

*Srinida Singh*

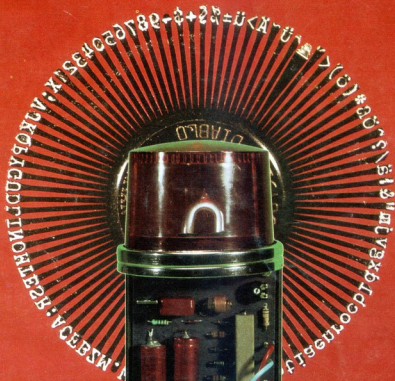

**typewriter  
as a printer**

**distress  
flasher**

**echo  
sounder**

**ZX  
extensions**

# elektor INDIA

1983

1 MAY

2 JUNE

3 JULY

4 AUG/SEPT

5

6 OCTOBER

**NOW**

BOOK ONE 1

**Rs. 45/-**  
PLUS  
**Rs. 5/-**  
**P & P**

In a beautiful bound Volume  
at no extra cost

elektor INDIA

up-to-date electronics for lab and leisure

BOOK ONE

1 2 3 4/5 6

Rs. 45/-

Our Back Issues are  
increasingly in  
demand  
**HENCE BOOK ONE**

**How to Order**

- 1) Send full amount by DD/ MO/ PO  
To :  
**Elektor Electronics Pvt. Ltd.,**  
3, Chunam Lane, D. Bhadkamkar Marg,  
Bombay-400 007.
- 2) Despatch will be made by  
Registered Post Parcel Only
- 3) **NO. CHEQUES-NO VPP**

Also Distributed by: **INDIA BOOK HOUSE**

**RUSH! STOCKS LIMITED**

# contents

<b>selektor</b> .....	7.15
Lasers: light sources with a future.	
<b>portable distress signal</b> .....	7.18
Wherever you may be in trouble, on the road, at sea, in the hills, this unit may bring help quickly.	
<b>ZX extensions</b> .....	7.22
Dedicated to the ZX computers, this article shows how you can carry out a number of extensions yourself and at low cost.	
<b>disco drum</b> .....	7.30
The drummer need no longer feel left out of the modern electronic group with our presentation of the 'user-friendly' electronic drum.	
<b>daisywheel typewriter printer interface</b> .....	7.32
This interface connects an electronic typewriter to a computer's Centronics output port to provide an inexpensive, high-quality printer.	
<b>maximum and minimum memory</b> .....	7.37
Suitable for storing positive and negative analogue voltages, this memory can be used in a variety of applications.	
<b>lead-acid battery charger</b> .....	7.39
Now lead-acid batteries are coming back into vogue, we present a design for fast charging such batteries without reducing their life.	
<b>PSUs on PCBs</b> .....	7.42
building power supplies the easy way	
<b>merging BASIC programs</b> .....	7.48
A single BASIC program can quite easily be formed by combining two existing files as this article shows. Software is also included to enable the JC to use the OS disk 2 routines.	
<b>echo sounder</b> .....	7.50
The season is almost upon us again when there are almost daily reports of yachts having run aground: many such unfortunate accidents may be prevented by this echo sounder.	
<b>versatile audio peak meter</b> .....	7.57
A peak meter with LED display that may be used with any sound system that has a power output between 400 mW and 250 W!	
<b>market</b> .....	7.61
<b>switchboard</b> .....	7.69
<b>EPS service</b> .....	7.72
<b>missing link</b> .....	7.74
<b>advertisers index</b> .....	7.74



Our front cover this month suggests two of the projects in this issue. The 'halo' is, of course, a daisywheel similar to that found in many high-quality computer printers. High-quality in this case generally also means high cost, but another, less expensive, daisywheel 'user', namely a certain type of electronic typewriter, can be used as a computer printer with very few modifications. We have designed a Centronics interface for a specific typewriter, the Smith Corona EC1100, which requires no actual hardware changes. The interface is, however, versatile enough for it to be relatively easily modified for other typewriters.

In front of the daisywheel is the portable distress signal described on page 7-18. This handy unit may bring help wherever you may need this: stranded on some country road in your car, in trouble while rambling in the hills, or off-shore with the rudder of your yacht broken, and in many other situations we hope you'll never get into.

A handwritten signature in black ink, which appears to be 'Suresh Srinivasan', is written across the bottom right of the page.

## DIGIPRINT-18



**AN IDEAL PERMANENT RECORD KEEPER  
FOR OFF-LINE ANALYSIS OF DATA FOR QUALITY CONTROL,  
CONSUMER APPROVAL OF PROCESS CARRIED OUT, STATISTICAL  
RECORDS, DATA LOGGING APPLICATIONS, WEIGHING SCALES AND  
FOR R & D PURPOSES.**

**Engineered for Reliability**

18-column  
Digital Numeral Printer  
with electronic interface

12	24	03	0028	C
12	24	04	0029	C
12	24	05	0027	C
12	24	06	0032	C
12	24	07	1006	Cx
12	24	10	1827	Cx
12	24	11	0028	C
12	24	12	0031	C

- SHARP WELL DEFINED CHARACTERS
- SPEED: 3 LINES/SEC ON 58 MM PAPER
- 3/2 COLUMNS OF SPECIAL CHARACTERS  
15/16 COLUMNS OF NUMBERS - 0 to 9
- ULTRA LOW POWER CMOS INTERFACE
- SERIAL OR PARALLEL BCD INPUT OPTIONS
- PRINT IN RED & BLACK TO DISTINGUISH  
ALARM AND NORMAL CONDITIONS
- TWO PRINT MODES - AUTO AND MANUAL
- PLUG-IN MODULAR INTERFACE CARDS  
FOR 6, 12 OR 18 COLUMNS
- TABLE TOP OR PANEL MOUNT MODELS
- DOOR WITH MAGNETIC CATCH

#### OPTIONS :

- 1) Real/elapsed time clock with print interval  
setters.
- 2) Automatic decimal point or character shifting  
circuits for special applications such as  
auto-ranging.
- 3) Portable battery powered printers.

• • •

Manufactured by  
**INSTRUMENT RESEARCH ASSOCIATES**  
POST BOX 2304, BANGALORE 560 023  
Grams: REASOCIATE Phone: 350830

# Hi Reliability Semiconductors from CDIL....

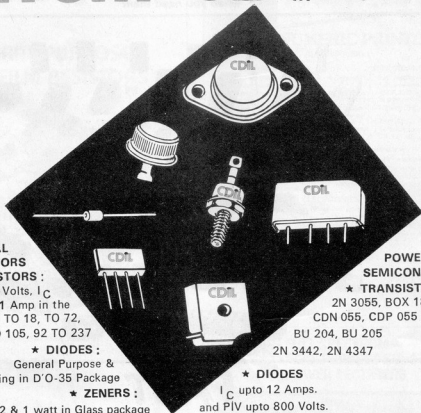

## SMALL SIGNAL SEMICONDUCTORS

### ★ TRANSISTORS :

$V_{CEO}$  upto 300 Volts,  $I_C$   
upto 1 Amp in the  
following packages : TO 18, TO 72,  
TO 39, TO 106, TO 105, 92 TO 237

### ★ DIODES :

General Purpose &  
Switching in D'O-35 Package

### ★ ZENERS :

1/2 & 1 watt in Glass package

## POWER SEMICONDUCTORS

### ★ TRANSISTORS :

2N 3055, BOX 18,  
CDN 055, CDP 055

BU 204, BU 205

2N 3442, 2N 4347

### ★ DIODES

$I_C$  upto 12 Amps.  
and PIV upto 800 Volts.

offer you a definite edge  
over others

NORTH ZONE DISTRIBUTORS

## J. M. ENTERPRISES

382, Lajpat Rai Market, Delhi-110006. Ph. : 235455, 238919 Telex : 031-5462





# FOR ELECTRONIC COMPONENTS

when you need them



## FAST

SEMICONDUCTORS • INTEGRATED CIRCUITS • MICROPROCESSOR & MEMORY CHIPS • DISPLAYS  
OPTO ELECTRONIC DEVICES • CRYSTALS & OSCILLATORS • TRIMPOTS • TRANSISTORS  
DIODES • TANTALUM CAPACITORS SWITCHES • CONNECTORS • SCR's etc.

#### Manufacturer's Include

Advanced Micro Devices, Analog Devices, Apex Microtechnology, CTS, Fairchild Semiconductor,  
Fujisoku, Fujitsu, General Instrument, Grayhill, Harris, Hitachi, Intel, Intersil, Matsushita, Mitome, Mitsubishi,  
Motorola, Mostek, National Semiconductor, NEC, P.M.I. R.C.A., Raytheon, Rockwell, Statek Corp., S.G.S.,  
Signetics, Silicon General, Siliconix, Synertek, Texas Instruments, Toshiba, Unitrode, Western Digital, Zilog.

## ELMATRONIC DEVICES

#### Head office:

14, Hahuman Terrace, Lamington Road, Bombay 400 007,  
Tel. : 362421 Gram: ELMADEVICE Telex: 11-5614

#### Bangalore:

15, Hotel Kamadhenu Annexe, Trinity Circle, M.G. Road,  
Bangalore - 560 008.

#### Pune:

17-A/2, Karve Road, 30, Prasad Chambers, Pune 411 004. Tel. : 35983  
Gram: ELMADEVICE Telex: 0145-505-ELMA

#### Trivandrum Resident Representative:

Mr. Koshy Eapen, "Roshni", University Road, P.O.  
Palayam, Trivandrum - 695034. Tel.: 64029.

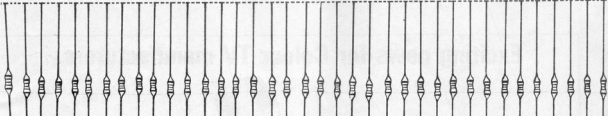

# RESISTORS

# MFR

**Sputtered  
metal film fixed  
RESISTORS 0.25 W**

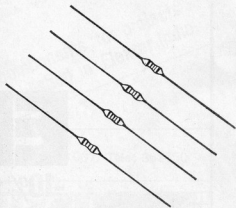

Formerly Manufactured For EXPORT Only  
Now Sales Permitted In INDIA

## MFR FOR

### Mil Specs Performance

These resistors are being exported to quality conscious users in EUROPE

## MFR FOR

### Prompt Supply

adequate inventory in E24 Series for ex-stock delivery

## MFR FOR

### Most competitive prices.

1% 100 ppm costs you only Rs. 50-00 per 100 We have Special Rates for bulk orders

Metal Film Resistors in 5% and 0.1% tolerance are also available.

Manufactured by :

**MFR Electronics  
Components Pvt. Ltd.**  
40, SDF II, SEEPZ  
Andheri (East) BOMBAY-400-096.

Marketed by :

**precious<sup>®</sup>** Electronics Corporation

- 3, Chunam Lane Dr Bhadkamkar Marg Bombay-400-007.  
Phone : 367459/369478
- 9, Athipattan Street Mount Road Madras 600-002  
Phone : 842718

## OUR MOST POPULAR PROJECTS

- PREAMPLIFIERS** :- For Magnetic/ceramic cartridge, tape head etc.
- AMPLIFIERS** :- 1 Watt to 100 Watt.
- SOUND EFFECTS** :- Graphic Equaliser, Door bell, Siren, Musical bell, etc.
- LIGHT EFFECTS** :- Light Dimmer, Running Light, Colour Organ etc.
- TIMER/CLOCKS** :- Crystal controlled Digital Clock, 1 to 17 minute timer.
- LAB INSTRUMENTS** :- 3½ Digit LED/LCD DPM, Simple Transistor Tester Function Generator.
- POWER SUPPLIES** :- Fixed and Variable Supplies up to 60Volts at 1Amp. Current, and Dual Supplies up to + 24 Volts.

## WE ALSO STOCK

"S.V Product" Drafting aids, "Solderon" Soldering Iron, "Calonix" Toggle Switches, "Vicky" Speakers, Heat sinks, Connectors, Transistors, SCRS Triacs, Diodes, LEDs, Capacitors, Resistors, Modular Switches, Tape Mechanisms, IC's Digital Displays, etc. of reliable make.

**components for projects published in Elektor India.**

**VISHA**  
ELECTRONICS

17, Kalpana Building 349, Lamington Road, BOMBAY-400 007. Tele: 362650

## WE OFFER FROM STOCK

**I.C.'s** : TTL, CMOS, MOS, LSI, Microprocessor, Micro computer etc.

**Zener Diodes** : 400 MW & 1 Watt

**LED's** : Red, Green, Yellow in 5mm and 3mm dia

**IC Sockets** : SMK & Molex make

**Trimpots** :

Multiturn Bourn's, VRN & Beckman make

**Single Turn cermets** :

EC as well as imported

**Floppy Discs** :

8" as well as mini floppy of memorex, & dyson make

Write to :



**ZODIAC**  
**ELECTRONICS**  
**CORPORATION**

2/12, Hirji Bharmal Trust Bldg. M.G. Road, Ghatkopar (E)  
Bombay 400 077. Phone No. : 5137225

## COMTECH



### INSTRUMENT—CASE TYPE-T-220

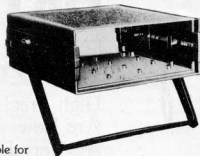

Suitable for  
**PORTABLE—TABLE TOP  
TEST INSTRUMENTS**

- Digital counters
- DMM
- Multifunction Meters
- Ph meters
- Size—220×230×56 to 92
- Moulded in ABS plastics
- Choice of colours. Beige & light gray
- Inclined handle

Also available

- Thumbwheel switches
- Display Bezel for 3½ digit
- Instrument clamps

For more information, contact:

**COMPONENT TECHNIQUE**  
8, Orion, L.P. Road, Andheri (W), Bombay-400 058.  
Tel: c/o 4224066



## NEW DOE SECRETARY

The government of India has made important changes in the department of electronics (DOE) with the appointment of Mr. S.R. Vijaykar as secretary in the place of Dr. P.P. Gupta. Mr. Vijaykar has been the chairman and managing director of the Electronics Corporation of India Limited. Dr. Gupta, who became secretary in May, 1981, will now go back to the Computer Maintenance Corporation as its chairman and managing director. The department will also have two additional secretaries, Mr. Ashok Parthasarathi and Dr. N. Seshagiri.

## MTB PLAN

A new package plan called "Material, Technology and Brand name" has been announced for the benefit of small-scale TV manufacturers in the country by the Electronics Trade and Technology Development Corporation. The corporation will float tenders for procuring 500,000 colour picture tubes and 300,000 black and white picture tubes, as a part of its effort to supply components to small manufacturers at a cheaper rate. The philosophy behind this scheme is to make bulk imports, along with technology transfer, to derive cost advantage. To overcome the competition faced by small manufacturers from the established units, the MTB plan allows the use of the trade name "ET and T" of the corporation by small units. Initially, the package would cover TV units but later it would be extended to video taperscorders, entertainment appliance, calculators, computers for schools, electronic telephone instruments and plain paper copiers.

The MTB's another objective is to achieve standardisation of technology and components by creating a large demand and a corresponding strong base, resulting in competitive prices for the consumer items, according to the Mr. P.S. Deodhar, chairman of corporation. In the next two or three years, the colour TV sets would be fully indigenised, he hopes. At least 70 per cent of the TV units are expected to become members of the MTB and even established units are eligible to take advantage of the scheme.

## TELECONFERENCE

The prophetic dictum, "Communicate, do not commute", (Sir Arthur C. Clarke) has become a fact of life. It is such a fact that the Overseas Communication Service of the government of India will shortly offer facilities for teleconferencing among participants in four locations from different parts of the world, on a regular, commercial basis. When this facility is available, experts could save crores of rupees spent on travelling abroad, accommodation in expensive hotels and conserve precious time, just by making a visit to the conference room of the OCS, Bombay, from where one could simultaneously have a dialogue with counterparts in four other locations, thanks to the satellite communication system for video conferencing and computer networking for business and industry.

The OCS was a witness to the first global teleconference on medicine, sponsored by the American Telephone and Telegraph Communications, on May 15, 1984. The participants were in 24 locations in 18 countries across 11 time zones and India. Bombay and Delhi were the venues. Bombay was connected to the USA by INTELSAT satellite and submarine cable. Reception at the OCS was trouble-free. Prof. M. Samii delivered a talk on the management of tumours in acoustic nerves from Hanover in West Germany. Representatives of World Health Organisation and International Telecommunication Union gave their remarks from Geneva. Perhaps, link with 24 locations was too ambitious. A lesser number would have been a greater success, felt the participants.

## PEICO PROJECTS

Peico electronics and electricals limited will invest approximately Rs. 16 crores in a number of new projects. The company has received letters of intent for oscilloscopes, frequency counters and timers, portable diagnostic ultra-sound instruments, X-ray diagnostic systems, micro motors, tape deck mechanisms and magnetic heads, in addition to industrial licences for the manufacture of dumet wires and other critical components. The chairman and

managing director of the firm, Mr. C.J. Seelan, has been quoted as saying that the price of colour TV could not be lowered unless the components were manufactured indigenously. Peico had already applied to the government for setting up a unit to manufacture components for colour TV sets.

## SATELLITE ANTENNA

Pioneer Electronics Limited, Bangalore, have obtained licence for the production of systems for receiving TV programmes directly from satellite. This system, TVRO, will enable viewers to see programmes from 10 different channels and a number of TV sets can also be connected to it. The system requires a flat area measuring 20' x 20' for installation. Each TVRO, costing about Rs. 99,000 (taxes extra) weight 600 kg, and programmes from the Middle East, USSR, France, UK, and East European countries can be received by the TVRO, it is claimed.

## OPTICAL FIBRES

Telecommunications network in the country will soon utilise optical fibres. Two lines using optical fibres would be first installed in Madras city and over a 100 km of optical fibre would be bought from European countries and used in the southern zone, according to the Union deputy minister for communications, Mr. V.N. Patil. Experimental use of optical fibres for a telephone network at Pune had been successful and in nine months, not more than six faults were reported from this segment.

## VCR POLICY

The government will shortly announce its policy on the manufacture of video cassette recorders and video cassette players. A high-level inter-ministerial committee has submitted its report in this regard. The general expectation is that the ceiling on manufacture of 500 VCR sets may be scrapped. There shall be no upper limit or else the limit will be enhanced. There are about 50 licensed VCR manufacturers in the country. The government would not allow bulk import of VCRs under any circumstances, official sources maintain.

## lasers: light sources with a future

The range of applications for lasers continues to widen. The interactions between laser research and the recent surge of growth in modern communications, data-storage and consumer systems are producing exciting results, in which 'custom-built' lasers are playing a central part.

In optical-fibre communications the long-wave laser is indispensable. The opto-electronic data-storage system with DOR discs (DOR stands for digital optical recording) requires a laser of somewhat shorter wavelength and relatively high power capable of burning the information into the disc in the form of small pits, as well as a laser of lower power for reading out the information. New consumer equipment, such as the Compact Disc system and the LaserVision video-disc system require inexpensive and relatively short-wave lasers.

Lasers are going from strength to strength, not just in professional applications but very definitely in consumer electronics as well. What is more, every application demands its own type of laser. Philips Research activities extend throughout the range of laser applications. Research topics include custom-built lasers, analysis of the properties of promising materials for laser manufacture, optimization of lasers, laser life and the development of appropriate technologies. Some notes on semiconductor diode lasers follow.

### Monochromatic and coherent

The intense and extremely fine beams of light required for the applications mentioned above can be produced by lasers. The light from a laser has a very special quality: it is not only monochromatic (i.e. it has

only one colour, one wavelength) but it is also coherent. This means that all light quanta emitted (photons) are in step with each other: they have the same phase. This is illustrated schematically in fig. 1.

Coherence is an essential requirement for some laser applications, for example in some optical-fibre communication systems. In other optical communication systems it is better to have less coherence, which means that after travelling a short distance the photons get out of step. To read out a Compact Disc, for example, coherent light is not absolutely necessary; what is required is light of one particular wavelength, in a beam that can be focused to form a very small spot.

### Pump action

The operation of a solid-state diode laser is very closely associated with the properties of semiconductors, in particular of two types. The first is the N-type semiconductor, in which the electrical conduction is provided by electrons (negative charge). The other is the P-type semiconductor, in which there is a deficit of electrons. The places that could be occupied by an electron are called 'holes'; these are positively charged. Like electrons, the holes can move, and in the P-type material the conduction is primarily due to the movement of holes.

The energy state of the electrons and holes is very important here, and we find that there are two kinds of energy band: the conduction band with relatively high energy and the valence band with relatively low energy (see figure 2). The electrons responsible for conduction in the N-type material are situated at the bottom of the conduction band.

When an electron falls into a hole (or rather, when an electron and a hole recombine), a photon can be produced. The energy of the photon, and hence the wavelength of the light, depends on the energy difference

between the conduction and the valence band.

Having said all this, we still have no laser light. Laser is an acronym for Light Amplification by Stimulated Emission of Radiation. Stimulated emission occurs because the presence of photons with a particular energy causes the recombination of electron-hole pairs that have a corresponding energy difference. The object is to retain inside the structure as many of these stimulating photons as possible. To keep this stimulated emission going it is necessary to ensure that enough electrons are 'pumped' into the conduction band and holes into the valence bands.

In the semiconductor laser this pumping is achieved quite simply by sending an electric current through an appropriate semiconductor diode.

### PN junction

When a layer of P-type material is applied on top of a layer of N-type material (figure 3) a PN junction is formed. Holes will now penetrate

3

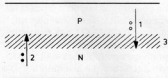

Figure 3. Schematic representation of a PN junction. 1) Holes in the P-type region, 2) electrons in the N-type region, 3) the transitional region, called the junction. From both sides, electrons and holes penetrate into the junction until a potential difference is built up that prevents any further movement of charge carriers.

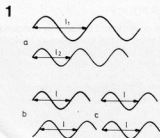

Figure 1. Schematic representation of waves of different wavelength and phase. a) Different wavelengths  $l_1$  and  $l_2$ , different phase. b) Same wavelength  $l$ , different phase; monochromatic. c) Same wavelength  $l$ , same phase; monochromatic and coherent.

2

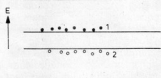

Figure 2. Energy-level diagram in a semiconductor. Here 1) is the conduction band with freely moving electrons, and 2) is the valence band with holes, which are also mobile.

from the P-type material into the N-type material and electrons will penetrate from the N-type material into the P-type material. As a result the P-type material becomes slightly negative in the neighbourhood of the junction. A state of equilibrium arises, because more electrons are repelled by the negative side and more holes by the positive side. However, if an electric current is passed through this junction, in the direction indicated in figure 4, additional electrons will be injected into the P-type layer and additional holes into the N-type layer. On one side of the junction there will now be extra electrons and on the other side extra holes. In these areas, in the right circumstances, light amplification by stimulated emission can now occur.

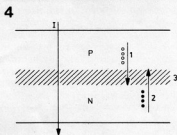

Figure 4. Schematic representation of a PN junction through which a current passes.

1) Injection of holes and 2) injection of electrons into the junction 3.) 4.) electric current.

#### Sandwich

As we have said, enough stimulating photons have to be kept trapped inside the structure. Furthermore, in a practical laser it is necessary to make sure that electrons and holes do not leak away from the structure, since it is their recombination that produces the photons. To meet these requirements the double-heterojunction injection laser was designed. It originated at Philips Research Laboratories in Eindhoven (the Netherlands), which patented a heterostructure semiconductor laser in the late sixties. ('Heterojunction' means that there is a junction between materials of different composition.) The basic construction of such a laser is a sandwich structure. The active layer (in which laser action can occur) is coated on both sides with layers of material of a slightly different composition. The composition is such that the refractive index of the coating is lower than that of the active layer. Laser light generated in the active layer is then totally internally reflected by the two coating layers.

In addition, the differing composition ensures that electrons and holes do not escape from the active layer. The result is that sufficient optical amplification takes place in the active layer. Measures now remain to be taken to keep part of the generated photons functioning as stimulating photons within the structure, while another part leaves the structure in the form of laser light.

Cleavage planes of the crystal in which the active layer is situated can function as partially reflecting mirrors. A typical double heterojunction injection laser structure is shown schematically in figure 5.

#### Materials used

Depending on the required wave-

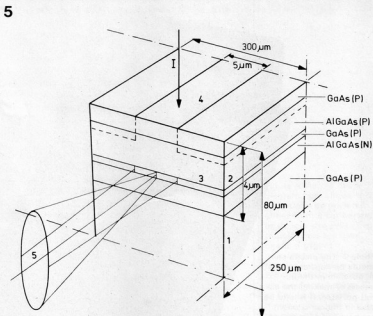

Figure 5. Typical structure of a double heterojunction injection laser with GaAs as the active layer. The dimensions are approximately 250 x 300 x 80 μm. The laser light leaves the laser from the front and back through the partially reflecting mirror. The light emitted at the back (not drawn) can be used as a signal for a feedback circuit that regulates the current through the laser in such a way as to obtain a constant level of luminous intensity.

1 is the current through the laser. 1) substrate, 2) active layer, 3) partially reflecting mirror, 4) stripe for current passage, 5) laser light.

length of the laser light, the materials used for such lasers are gallium arsenide (GaAs), aluminium gallium arsenide (AlGaAs) and indium gallium arsenic phosphide (InGaAsP). The multilayer structure is usually produced by the technology known as liquid-phase epitaxy (LPE). In this technology a substrate (a crystal wafer on which the layers are grown) is brought into contact with a hot saturated solution. As the solution cools the dissolved substance crystallises on the substrate. The substrate used for lasers of relatively short wavelength (780-900 nm; a nanometre is one-thousand-millionth of a metre) is gallium arsenide. Epitaxial growth of the multilayer structure (active layer plus sandwiching layers) then takes place from a solution in which gallium is the solvent and aluminium and arsenic are the solutes.

The AlGaAs lasers produced in this way have an important application in the playback of the Compact Disc. For longer wavelengths (1300 nm and 1550 nm) InGaAsP lasers are generally used. Their active layer consists of InGaAsP and the sandwiching layers of InP. Their primary

application is in optical-fibre communications.

Many modifications can be made to the layer structure to optimize the laser for a particular application, so that 'custom-built' lasers can be produced. Lasers for the Compact Disc, for example, should emit photons that become slightly out of phase after travelling a couple of centimetres; a laser beam reflected from the surface of the disc will not then show interference with the incoming laser signal. In telecommunication applications, on the other hand, lasers are often used in which the photons keep in phase with each other over greater distances.

#### Life

When a laser diode, as described here, is run continuously, some of its characteristics slowly change. Eventually the laser has to be replaced. No complete explanation can yet be given for this ageing effect, but infrared and electron microscopy give some idea of the kind of changes in crystal structure that can occur.

Philips press release

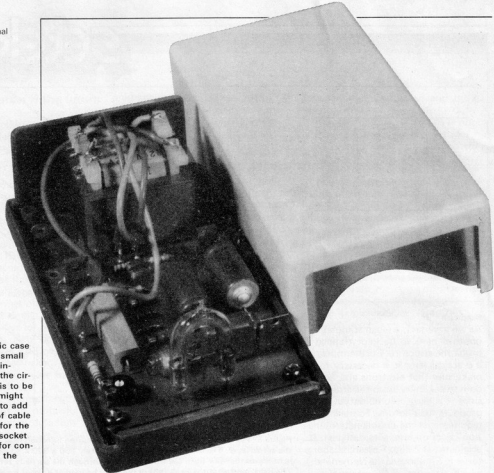

Photo 1. The plastic case should be kept as small as possible in the interests of making the circuit portable. If it is to be used in the car it might not be a bad idea to add a suitable length of cable fitted with a plug for the car's cigar lighter socket or crocodile clips for connection directly to the battery.

# portable distress signal

Who, on a clear summer night, has never been surprised to see a very bright star winking in the distance? Generally it is not a star at all (no, it's not a UFO either) but rather the high-power flashing light indicating the presence of an airliner 20 or 30 miles away. In the field of aeronautics it is taken for granted that the lights should be visible at such distances but there is no reason why the same principle cannot be applied to other applications.

a portable 'Mayday flare' for the motorist with engine problems, the pleasure sailor in trouble, or the stranded mountaineer

The flash light tube, which is also used in stroboscopes, is capable of producing very intense light, surpassed only by the laser. Unlike the laser, however, it has quite a low energy consumption because, although the flashes are high intensity, they are of very short duration. This fact led to the idea of using it as the basis for a portable 'distress signal' that could be used to attract the attention of anybody who might be in the area.

## General layout

The different functional sub-assemblies of the circuit are clearly visible in the block diagram of figure 1. Two different types of supply can be used: either a 12 V lead-

acid car (or boat) battery or four 1.5 V dry cells connected in series. The voltage chosen is applied to a converter giving an output of 220 V. This consists basically of an astable power multivibrator and a transformer with a centre-tapped primary winding. This primary is, of course, fed the low voltage and causes 220 V to be output from the secondary. Note the positioning of the transformer which is typical of this sort of application.

The next step is the voltage doubler, to which the output of the transformer is fed. The output of the doubler is fitted with a preset that is used to vary the frequency of the flashes. The other side of the preset is connected to a pair of diacs in series

that limit the voltage threshold. A diac remains switched off in the range from  $-30$  to  $+30$  volts and conducts as soon as the voltage exceeds either the positive or negative threshold. This produces a current peak that triggers the thyristor in the next block. When the thyristor is triggered the high-voltage transformer connected to it fires the strobe light. Further information about how a strobe light operates can be found in the article entitled 'strobe light control' published in *Elektron* no. 82, February 1982.

### The circuit

The circuit diagram of figure 2 is almost as simple as the block diagram we have just been looking at. The voltage supplied

by the battery or the four dry cells is applied to the points  $U_B$  and 0. The multivibrator consisting of T1 and T2 contains two RC networks, R7/C4 and R8/C5, that determine its operating frequency which, in this case, is about 80 Hz. The output of the MMV feeds two symmetrical branches.

The transformer (Tr2) cannot, of course, be driven by T1 and T2 directly because their collector currents are much too small, at only a few milliamps. This explains the presence of the power stages in the emitter lines of T1 and T2. One stage is based on T3 whose base current remains small even when the transistor is conducting, whereas its collector current is large. There is a corresponding power stage, T4, on the other side and the collector of

portable distress signal

1

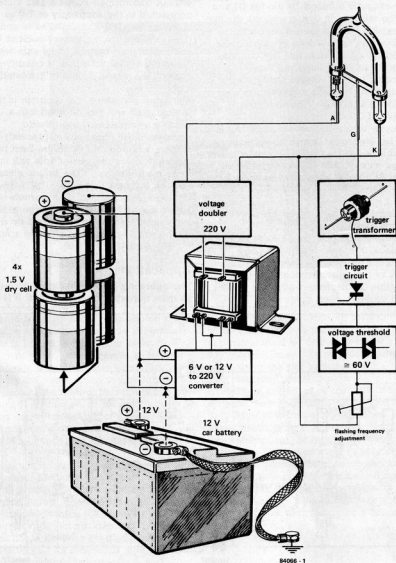

Figure 1. As the block diagram here shows this circuit can be powered either from a car battery or by four dry cells. Two transformers are used, one is a trigger transformer for the xenon tube and the other is a 220 V one with a secondary winding of either 12 or 6 V. In this case, however, the low voltage winding becomes the primary so that 220 V is available at the output of the transformer.

each power switching transistor feeds half of the primary winding of transformer Tr2. The main purpose of resistor R5 is to limit the base current of T3 to a reasonable level while the transistor is conducting and R9 permits this transistor to be quickly switched off by T1. As we will see later, the power transistors do not need a heat sink as they are unlikely to become very warm.

Moving on to Tr2 now we see that the inductance consisting of the primary winding of this transformer is charged when T3 conducts. This energy remains stored when the transistor switches off but current spikes are generated which would be sufficient to destroy T3 were it not for the presence of D5. While one half of the primary winding of Tr2 is being charged the other half transmits the energy it has stored so that a square wave is induced on the secondary winding.

This voltage is rectified by diodes D1 and D2. The resistors in series with the diodes (R2 and R3) prevent them from being destroyed by an overdose of amps when C1 and C2 are discharged. The combination of these two diodes and two capacitors forms a voltage doubler with the result that there is a potential difference of about 620 V between the positive of C1 and the negative of C2.

The same voltage is present across flash tube La1 and roughly half this value is available at the C1/C2/R1/R4 junction. The charge on capacitor C3 is controlled by preset P1 and these two components form a sort of time-base. A pair of diacs connected in series after P1 present a very high impedance when they are not conducting. The charging time of C3 depends on the position of P1. As soon as the diacs' threshold level is reached ( $\approx 60$  V for the pair) the thyristor is triggered by the pulse arriving at its gate. Capacitor C3 discharges abruptly via Th1 which causes a short pulse to be

generated at the primary of transformer Tr1. This pulse appears at the secondary of the transformer as a very high voltage, more than 1 kV, which is sufficient to cause the xenon tube to flash.

The gate current of thyristor Th1 is limited by resistor R1. By adjusting P1 the flashing frequency can be varied between 1 and 15 flashes per second. This frequency is also, to a certain extent, dependent upon the voltage supplied by the batteries.

### Constructional details

This circuit can be constructed on the printed circuit board shown in figure 3. The various connection points for transformer Tr2 are also clearly marked on the component overlay. If the circuit is powered by means of four 1.5 V dry cells a  $2 \times 6$  V/800 mA transformer is needed. The 'automotive' version uses a  $2 \times 12$  V/400 mA transformer. Points X and Y are connected to the secondary of Tr2 as these are two 220 V points. The + and 0 points connect to the battery pack or the poles of the car battery. Make sure when fitting the strobe tube that its polarity is correct; the anode is usually indicated by a dot.

The great advantage of this circuit is that it is very small and can be fitted into a suitable small plastic case (plastic because of the high voltage present!) and is then truly portable. With the flash tube mounted inside the case a hole will have to be made to enable the light to shine through (strangely enough). The photograph at the start of this article shows the end result. If the range of the lamp must be increased this can be done by the simple expedient of fitting a reflector behind it.

### Applications

The operating life of this circuit is one of its most important characteristics. If it is

Figure 2. Virtually any xenon tube will work in this circuit provided it is accompanied by the correct firing transformer. Naturally, the higher the power rating of the strobe light the brighter will be the flash.

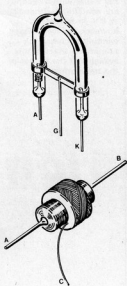

2

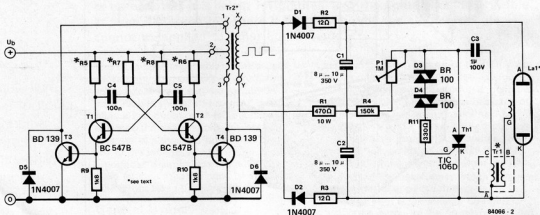

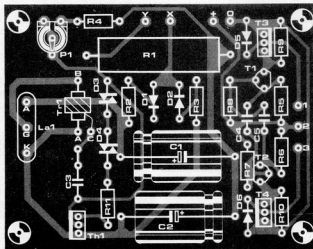
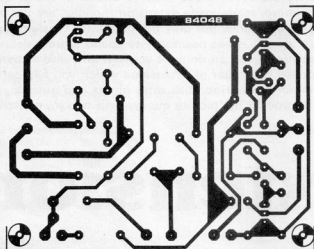

powered by a car battery this should be no cause for concern as some proverbial knight is bound to fly to your assistance long before the battery begins to suffer (we hope!). If, on the other hand, four 1.5 V dry cells are connected in series a continuous operation of four hours can be expected. Adding an on/off switch improves this considerably, of course. Then the signal need only be started when there is a chance that someone may see it.

The applications for this circuit are many and varied. Mountaineers or cavers could include it in their pack under the motto of being prepared. Another obvious use is in the car especially as the flashes produced are very bright but not dazzling. Pleasure sailors could likewise be glad to have the circuit flashing an indication of their position in the event of distress.

There is one important point to note about the circuit, namely that there is a very high voltage present, especially across capacitors C1 and C2. On no account

should you start working on the circuit while this voltage is present. The capacitors must be first allowed to discharge fully or they may be discharged by shorting the two terminals with a very well insulated piece of wire.

Everybody knows, of course, that there is no possible reason for needing this circuit; 'My car is properly maintained and never breaks down' you say, or 'I never go mountaineering just before the weather unexpectedly deteriorates', or (this one is asking for trouble) 'Murphy doesn't exist!'. The trouble is that Murphy does exist and is always just around the corner with some new catastrophe. This circuit may just tip the balance in your favour for a change. ■

#### Parts list

##### Resistors:

- R1 = 470  $\Omega$  / 10 W
- R2, R3 = 12  $\Omega$
- R4 = 150 k
- R5, R6 = 820  $\Omega$  if  $U_B = 6$  V or 1k8 if  $U_B = 12$  V
- R7, R8 = 47 k for  $U_B = 6$  V or 100 k for  $U_B = 12$  V
- R9, R10 = 1k8
- R11 = 330  $\Omega$
- P1 = 1 M preset

##### Capacitors:

- C1, C2 = 8 ... 10  $\mu$  / 350 V electrolytic
- C3 = 1  $\mu$  / 100 V
- C4, C5 = 100 n

##### Semiconductors:

- D1, D2, D5, D6 = 1N4007
- D3, D4 = 9R 100 diac
- T1, T2 = BC 547B
- T3, T4 = BD 139
- Th1 = TIC 106D

##### Miscellaneous:

- La1 = xenon tube flash lamp
- Tr1 = trigger transformer for La1
- Tr2 = mains transformer, 2 x 6 V, 800 mA, for  $U_B = 6$  V or 2 x 12 V, 400 mA for  $U_B = 12$  V

Figure 3. The flash tube may be mounted on the printed circuit board shown here or it may be mounted separately depending on the type of case chosen. To avoid confusion when fitting the components it is important to remember that the diacs do not have a polarity.

One of the great attractions of the ZX computer (ZX-81, ZX-spectrum) is its low price. However, if you want to extend it, things do not look so good any more: ready-made extension modules are not exactly cheap. This is, of course, not only the case with Sinclair computers. At the same time, it is not necessary to spend a great deal of money on more facilities: you can do a lot yourself and save money. This article describes a number of extensions which you can carry out yourself: memory extension, disk drive inputs and outputs, video output for improving the picture quality, and two joy-sticks for the Spectrum.

# ZX extensions

more bytes,  
more inputs,  
more  
outputs, . . .

SCART = Syndicat des Constructeurs d'Appareils Radiorécepteurs et Téléviseurs = (French) Association of radio and television receiver manufacturers. This association decided some time ago to terminate various inputs to, and outputs from, TV receivers into a 20-pin socket. This is becoming a European standard.

Before discussing the extensions in detail, let us first see what we have to work with. The data, address, and control buses are not buffered at the edge connector of the ZX 81. One of the first requirements in an extension scheme is therefore a buffer stage. It connects the computer via a control circuit and some interface logic to an Elektor bus board, into which most other extensions can then be connected (see figure 1). The buffer cannot be used with the ZX-Spectrum, as the memory extension can be provided internally in this computer, and the other extensions do not really need a buffer.

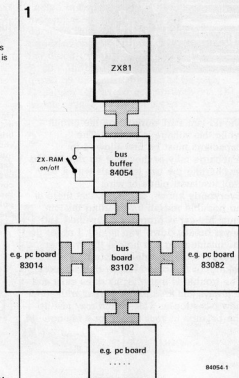

Figure 1. Block schematic of the ZX81 extension. The bus buffer board provides connection to the Elektor bus board.

A TV interface in the ZX computer provides a suitable signal that is made available at the video outputs. These outputs enable a monitor or TV receiver with SCART or A/V output sockets to be connected to the computer and so ensure that a high-quality picture is produced. Apart from the buffer circuit, we have not designed any printed-circuit boards for the extensions described. The reasons for this are that the circuits are small and uncomplicated enough to be wired conventionally and that many of you may not wish to use all the driver stages. The circuit for the video output may be small enough to fit into the case of the computer. The ZX 81 may, at least as far as hardware is concerned, be connected to the VDU card described in our October 1983 issue via the buffer stage and in that way be provided with a high-quality video output: 24 lines of 80 characters each. You will have to write the necessary software yourself. A further point before we come to the details: we have not tested whether the operational program of the ZX ROM allows corresponding jumps but think it probably will. To be able to tackle this extension, you need to know your way around the ZX 81 ROM handbook and Elektor's own Paperware 3 as the software may prove quite challenging.

## Buffer stage

By far the larger part of this circuit (see figure 2) is self-address. The address bus is buffered by IC1 and IC2, and most control lines by IC5. These three ICs are type 74LS244 three-state line drivers. The enable inputs,  $\overline{G1}$  and  $\overline{G2}$  (Pins 1 and 19), of the ICs are permanently connected to earth so that the drivers are always active. Pull-up resistor R1 ensures that the  $\overline{BUSRQ}$  input of the computer (a CPU input) is logic high unless taken low by some external circuit.

The data bus is buffered by a 74LS245 two-way, three-state driver IC. The change of direction is controlled by the RD signal of the Z80 microprocessor in the ZX 81: this signal is applied to the DIR input (pin 1) of



IC4 from the output (pin 3) of the control bus buffer IC5. When the  $\bar{G}$  (enable) input of IC4 is logic high, all inputs and outputs of the buffer become high impedance (the 'third state') and the data bus is disabled. NAND gate N34 and IC3 form a decoder for the lower 8 Kbyte block of the ZX 81. This block contains the ZX ROM. When the memory is accessed (MREQ logic low), IC3 is enabled. If at the same time the three highest address lines are logic 0 (= ROM range), the output (pin 15) of IC3 becomes low, the output of N34 goes high, and the data bus buffer is disabled. In all other cases, pin 15 is logic 1, when the external RAM or the I/O at address \$2000 may be accessed. Apart from these, about 250 I/O addresses are accessible via A0...A7 and IORQ as we will see later.

All this is true, provided switch S1 is closed, which ensures that the internal RAM of the ZX 81 is disabled. This is necessary because the internal RAMCS signal of the ZX is held logic high. If you want to work with the internal RAM, switch S1 should be opened. When external equipment is then connected to the ZX, problems may arise during writing of data owing to the incomplete internal decoding of the ZX 81. This must be borne in mind when the addresses for the drive connections are being fixed, so that the computer can be used as a drive computer without the RAM extension.

Also because of the internal construction of the ZX 81 — in this case relating to the video monitor — it is essential to combine CPU signal M1 with the address line A15 (the M1 signal in the ZX 81 has been misused for monitor control). This has the disadvantage that only data may be loaded into the upper 32 Kbyte range, but no commands.

Where the printed-circuit board shown in figure 3 is used, construction of the buffer stage should present no problems. The pin connections of the extension plug are shown in figure 4. The board and plug are best connected by a length of flat ribbon cable. The connection to the bus board for instance, that described in our January 1984 issue) may also be made with flat ribbon cable. It is, however, simpler and better, though also more expensive, to fit a 64-way female and male connector to the buffer and bus boards respectively: this enables the two cards to be plugged into one another.

### Power supply

Although the stabilized +5 V as well as the unregulated +9 V supply in the ZX computer may be used for the extension circuits, there is a limit to the additional load that can be placed upon the internal power supply. It may be best, particularly if further extensions are to be added at a later date, to build a new (additional) mains power supply, for instance, that described in the January 1983 issue of Elektor U.K. The forthcoming

2

ZX extensions

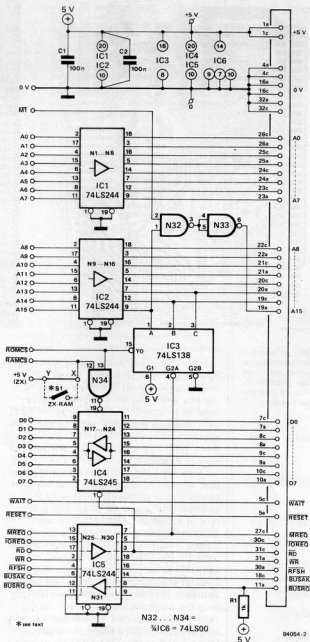

Figure 2. The circuit of the bus buffer consists basically of four bus drivers.

issue of Elektor India is also planned to contain a new mains power supply for computers. If, however, you plan to incorporate only some of the extensions, the power supply shown in figure 5 will suffice: this can provide a constant current of up to 1 A. Capacitor C1 is a single 2200  $\mu$  electrolytic or two 1000  $\mu$  ones in parallel.

### Memory extension for the ZX 81

This is probably the most needed extension for the ZX 81. It is based on the

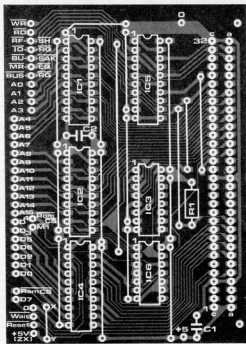
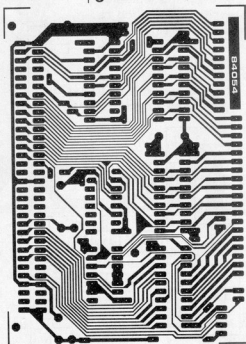

Figure 3. The pc board of the bus buffer makes an uncomplicated and clean construction possible. It may be plugged into the Elektor bus board.

#### Parts list (only for buffer circuit)

#### Resistors:

R1 = 1 k

#### Capacitors:

C1, C2 = 100 n

#### Semiconductors:

IC1, IC2, IC5 = 74LS244

IC3 = 74LS138

IC4 = 74LS245

IC6 = 74LS00

#### Miscellaneous:

PC Board 84054

Flat ribbon cable

Plug and socket connector

for ZX81

S1 = microswitch (optional)

64-way female connector

(optional)

Table 1. The address range in which the universal memory card fitted with eight 6116 RAMs is decoded by the DIL switch on the board. Other positions are, of course possible, but the ones shown are the most important for the ZX81. RAMTOP is only a theoretical value here (see text).

'universal memory card' published in Elektor U.K. in March 1983. Cards with a smaller capacity do not make sense, as the one used may be completed piecemeal as required. The '16 K dynamic RAM card' (Elektor U.K. April 1982), or the '64 K dynamic RAM card' (Elektor India October 1983) may also be used, but you will have to modify them yourself. The 'universal memory card' has two real advantages: first, in contrast to dynamic RAM cards, it solves timing problems of static RAMs, and, second, it may be fitted with a mixture of RAMs and EPROMs. The latter makes it possible therefore to store games, control programs, or even the software for the VDU card. To enable EPROMs to be programmed, the 'Z80 EPROM programmer' as published in our February 1983 issue may be fitted directly onto the universal memory card. As the card can be provided with 28-way connectors, the 5564/5565 8 Kbyte memory (static RAM) or the 2764 EPROM, or both, may also be used. The relatively high price of the former ICs will no doubt be coming down over the next 6...12 months. It is therefore seen that the card can provide a memory capacity of up to 64 Kbyte which is more than the ZX81 can address.

Table 1

Address range	DIL switch	RAMTOP
	8 4 2 1	(see text)
8 K ... 24 K	1 1 0 1	24 576
16 K ... 32 K	1 0 1 1	32 768
32 K ... 48 K	0 1 1 1	49 152
48 K ... 64 K	0 0 1 1	65 536

We have no doubt that most of you will start by using eight 6116 ICs to give a 16 Kbyte RAM. Only the second contact of the DIL switch (2) on the address decoder of the memory card is then closed. The card is addressed from 8...24 K (\$2000...5FFF). The ROM lies in the range below that. This gives 8 Kbyte of BASIC memory and 8 Kbyte of machine code and data memory.

If you want to reserve an address range for I/O ports, for instance, for the switch outputs which are described below, put the card in the range 4000...7FFF. This will make the range 2000...3FFF available for these ports when DIL switch '4' is closed. A general remark about the decoding of the memory card: because of the two's complement arrangement, the four highest address bits must be inverted, as shown in table 1.

The memory extension is tested by reading the system-variable RAMTOP as described in chapter 26 of the BASIC manual of the ZX81. Be careful, however, because with extensions above 32 Kbyte (ROM range), RAMTOP does not change. Evidently, Sinclair have not foreseen the possibility of such an extension to their operating system, and there is therefore no facility for testing the RAMTOP from decimal 32767 downwards. This means that with this extension the RAMTOP has to be set every time after switch-on. If, for instance, you have extended the memory to 48 Kbyte (8 Kbyte ROM, 8 Kbyte reserved for I/O, and 2 x 16 Kbyte RAM), you have to write:

■ POKE 16389.192

■ NEW

For other extensions these instructions will

have to be recalculated with the help of chapters 26, 27, and 28 of the BASIC handbook.

## Memory extension for the ZX Spectrum

An external extension of the Spectrum memory is not necessary as the main board has already been prepared for this (and in the 48 K Spectrum it has been completed during manufacture). Apart from the eight TI 4532 or 3732 memory ICs (IC15... IC22), it is necessary to insert four TTL ICs: IC23 (74LS32), IC24 (74LS00), and IC25 and IC26 (both 74LS157 — NOT National Semiconductor).

There is a point to note in respect of the memory ICs mentioned: these are not, strictly speaking, 32 Kbit memories, but 64 Kbit stores of which it has been found during the final test in manufacture that one of the 32 Kbit sections is defect. An addition to the type number indicates which of the two sections is usable so that you must bear this in mind during the addressing. The Spectrum board has a wire bridge close to the Z80 which must be connected to +5 V or earth, depending upon which section can be used. This is certainly of great economical advantage to Sinclair, because these ICs are very cheap indeed, particularly when they are purchased in bulk. The individual Spectrum user does not have this advantage, because these reject ICs are practically not available in the retail trade. Fortunately, there is another possibility: using the 4564 (= 2164, 3764, 4164, 4864, 8264, depending upon the manufacturer) in its 200 ns version. These ICs are of course readily available and probably at prices not much higher than those of 32 Kbit ICs. Where the bridge is connected to in this case does not matter as both sections may be addressed.

There is no need to worry about having to do without the other 32 Kbytes, because we have designed a small circuit, 'soft switch', which allows the Spectrum to use either half.

The soft switch circuit is shown in figure 6. Gates N3 and N4 form a NOR latch whose inputs are enabled by gates N1 and N2 when address \$0001 (= decimal 1) is selected on the address bus and the IORQ signal is active. The decoder forms a wired OR connection.

With the instruction IN 1

the address, the IORQ signal, and an RD are generated and output Q goes logic low.

With the instruction OUT 1, n (n is any number between 0 and 256)

the address, the IORQ signal, and the WR signal are generated and output Q goes logic high.

Point A in figure 6 is the centre of the wire bridge near the Z80 mentioned above. The 10 k resistor may be soldered on the Spectrum board instead of the relevant section of the wire bridge.

4a

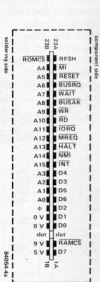

b

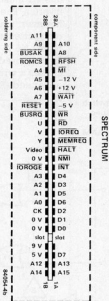

ZX extensions

As the bistable is biased by C1, output Q is logic 0 immediately after switch-on. You therefore leave the normal memory range with instruction OUT and reenter it with instruction IN.

The extra 32 Kbytes may be used for machine language programmes or subroutines. There is at all times one restriction: the system variable RAMTOP must be located below the switchable range (how is described in the BASIC handbook of the Spectrum). If you therefore want to make use of the full 2 x 32 Kbyte, you have only 16 Kbyte available for the BASIC program. If you locate RAMTOP so that 32 Kbyte remain available for the BASIC program, 2 x 16 Kbyte are retained in the switchable range. As you may locate RAMTOP more or less where you please (but, of course, not in the ROM range), it is possible to choose the most beneficial memory division for the particular program.

## Drive computer

If you want to actuate just one relay, or two relays alternately, the small extension shown in figure 7 may be used with the ZX81. With the Spectrum, the address

5

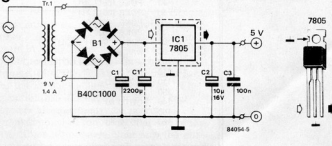

Figure 4a. Pinout of the edge connector of the ZX81...

Figure 4b. ... and of the ZX Spectrum.

Figure 5. This simple mains power supply, providing 5 V at 1 A, suffices to power all extensions.

decoding has to be supplemented, for instance as shown in figure 6. Only address line A1 must then be inverted by the free inverter. The principle remains the same, however: when the address decoder recognizes a valid address (the gates below N6 in figure 7, together with R4, form a wired OR connection), the software causes a write or read pulse to be generated (RD or WR goes logic low), and

Figure 6. The soft switch circuit for the ZX Spectrum gives access to 32 Kbyte additional RAM memory.

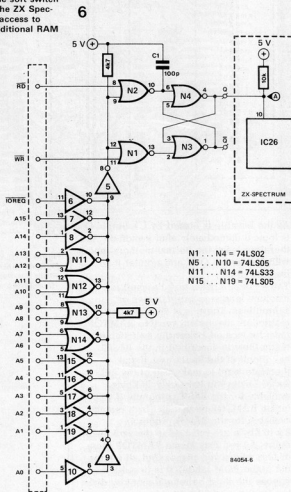

Table 2. This small program enables operation of the circuit of figure 7.

Table 2

10	REM switch control
20	POKE 16515,219
30	POKE 16516,0
40	POKE 16517,201
50	POKE 16518,211
60	POKE 16519,0
70	POKE 16520,201
80	PRINT "IN (1) or OUT (2)?"
90	INPUT X
100	IF X = 0 THEN GOTO 130
110	IF X = 1 THEN GOTO 150
120	GOTO 80
130	LET Y = USR 16518
140	GOTO 80
150	LET Y = USR 16515
160	GOTO 80

this sets or resets the NOR latch formed by N3 and N4. Basically, this is the same circuit as for the soft switch. The driver stages switch the relays on or off under the control of the latch. The drivers consist of a bias resistor, a Darlington transistor, and a free-wheeling diode. If only resistive loads are switched by the transistor, the free-wheeling diode is, of course, not necessary. The current through the transistor may be 500 mA maximum and the relays must therefore be chosen accordingly.

Table 2 shows a small program for the ZX81, which is self-evident from lines 80 and 90. If you want to include this program in a larger one, the jump addresses for the GOTO instructions must be changed accordingly. The first line of the composite program must contain a REM, because the POKE instruction in this range are for writing only.

The wired OR connection is retained even after the supplementary address decoding has been added. The program for the Spectrum is reduced to a simple, single line

OUT 3, Y  
or  
IN 3

where Y may be any decimal number between 0 and 256.

It is important that in the Spectrum the IORQ signal is used and not, as in the ZX81, the MREQ signal.

Figure 8 shows a further control circuit which not only makes eight switched outputs, but also eight inputs on request, available. The driver stages are similar to those in figure 7, but here they are controlled by latches (74LS374) instead of a bistable. The level at the output of IC4 is held until the computer writes a new word onto data lines (D0...D7).

The data can (also) be set by switches S1...S8 the levels of which (switch closed = 0) are sensed by IC5. Pull-up resistors R9...R16 ensure an unambiguous input level into IC5. The actual function of the eight switches depends on which of the sections is controlled and on the program. Output port IC4 is enabled by the output (pin 11) of address decoder N11 and the WR signal: both these signals are applied to AND gate N12 (note that although this is, strictly speaking, an OR gate, it functions as an AND gate because all signals are active when low). The memory driver accepts the data word from the bus at the leading edge of the pulse at pin 11 of IC4. The input port is likewise enabled by the address decoder, but in this case in conjunction with the RD signal. The AND gate is here formed by N13. The address decoder is again constructed as a wired OR gate and decodes hex addresses 3FE0 and 3FE1. These are used instead of the more obvious FFFF to prevent problems with incomplete decoding in the ZX81 when the internal ZX RAM is used. This is, of course, only so during reading when both the input port and the internal RAM are scanned: a typical case of double ad-

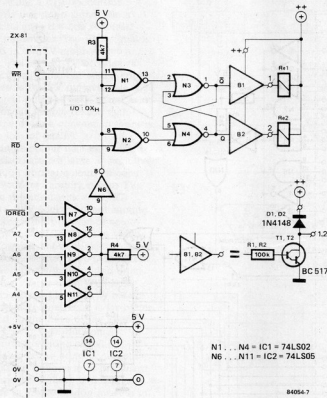

Figure 7. This small control output enables the ZX81 or the ZX Spectrum to switch two relays alternately.

addressing. The addresses chosen can also be decoded fairly simply and are located below the RAM range in an unused internal section of the ZX81. This is, of course, only so if the internal RAM is used. When a memory extension is added, make sure that these addresses remain available for I/O operation: the extension must therefore be located in the range starting at \$4000. The conversion of the addresses from hexadecimal to decimal is described fully in the handbook, so that you can readily access the addresses mentioned with PEEK and POKE instructions.

### Joy-sticks for the Spectrum

The new ZX interface II offers the possibility of connecting two joy-sticks to the Spectrum and read ROM modules (with games). However, at almost £30.00 (at least in the UK; prices are higher overseas) this is not exactly a cheap addition. If you want to be able to read ROM modules, this can be done without the Sinclair interface, and at the same time you can connect the two joy-sticks directly.

Figure 9 shows a cross-section of the Spectrum board. The connections for the keyboard are located directly under, and somewhat to the right of, the ASTEC modulator. Chapter 23 of the Spectrum BASIC handbook gives some very important information about addressing the keyboard.

The cursor keys (arrow keys 5...8) may

Table 3

IN KEY \$ = 5	IN 61486	data bit 4: ←
IN KEY \$ = 6	IN 61438	data bit 4: ↓
IN KEY \$ = 7	IN 61438	data bit 3: ↑
IN KEY \$ = 8	IN 61438	data bit 2: →

If the indicated bit is '0', the indicated key is pressed.

Table 3. During scanning of the cursor keys on the IN instruction, the ZX81 uses two memory cells: 61486 and 61438. Because of this, it is not possible without some further work to control the cursor with the joy-stick.

Table 4

IN KEY \$ = 1	IN 61486	data bit 0: ←	(1)
IN KEY \$ = 2	IN 61486	data bit 1: →	(1)
IN KEY \$ = 3	IN 61486	data bit 2: ↓	(1)
IN KEY \$ = 4	IN 61486	data bit 3: ↑	(1)
IN KEY \$ = 5	IN 61486	data bit 4: trigger	(1)
IN KEY \$ = 6	IN 61438	data bit 4: ←	(2)
IN KEY \$ = 7	IN 61438	data bit 3: →	(2)
IN KEY \$ = 8	IN 62438	data bit 2: ↓	(2)
IN KEY \$ = 9	IN 61438	data bit 1: ↑	(2)
IN KEY \$ = 0	IN 61438	data bit 0: trigger	(2)

be scanned with the instructions given in table 3. This can be tested with the program in table 5 which enables the writing of horizontal OR vertical lines on the screen. Interface II uses the number keys for the joy-sticks (see table 4). The IN instruction has a great advantage in that various directions may be scanned simultaneously. From a comparison of the two tables it becomes clear how the cursor may be controlled with a joy-stick and

Table 4. This is how the two joy-sticks may be sensed with IN instructions. As the five data bits are detected simultaneously, it is possible to realize graphic functions relatively quickly.

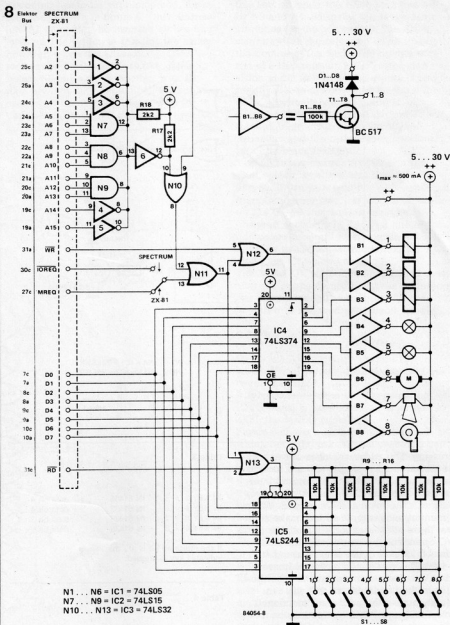

Figure 8. The largest of the extensions for the ZX81 and ZX Spectrum makes eight freely programmable output ports and eight input ports available.

also why Sinclair has not provided this facility: the joy-sticks use the addresses 61486 and 61438. Most current joy-sticks have only one (common) earth connection which must be used for selection. As you can see from figure 9 that cursor control is

Table 5

10	LET Z = 86
20	LET X = 127
30	IF IN KEY \$ = 5 AND X > 0 LET X = X - 1
40	IF IN KEY \$ = 6 AND Z > 0 LET Z = Z - 1
50	IF IN KEY \$ = 7 AND S < 174 LET Z = Z + 1
60	IF IN KEY \$ = 8 AND X < 254 LET X = X + 1
70	PLOT X, Z
80	GOTO 30

Table 5. This simple program enables the drawing of vertical or horizontal lines on the screens with the cursors. With small modifications it may also be used for trying out or testing the joy-sticks (see text).

therefore not possible this way because at all times only one of the common lines (1, 2, 3, 4, 5 or 6, 7, 8, 9, 0) may be used: they cannot be used simultaneously. At the same time, the figure shows how you can connect two joy-sticks to the Spectrum without using interface II. All you need to know is the plug pinout of the joy-stick. Figure 10 shows the standard pinout, in this case of the Atari joy-stick as used with the Sinclair interface II. If you use other types, check the pinout with an ohmmeter. Otherwise, the connections may be made as shown in figure 11 with, for instance, flat ribbon cable. The program of table 5 may still be used by changing the key numbers accordingly.

### Video output

Normally, the ZX computer is connected

to the aerial input of a TV receiver. The computer contains a UHF modulator which converts the video signal into a UHF signal similar to the one received from the TV transmitter. The UHF signal is demodulated in the TV receiver into a video signal. For normal TV broadcasts this is perfectly all right, but with a computer so close to the TV receiver this is, from a technical point of view, a bad solution, if only for the simple reason that because of the double conversion there is bound to be loss of quality.

Nowadays, single-colour data monitors (green or amber) are available at attractive prices, although normal colour versions remain pricey. Many modern colour TV receivers are provided with a SCART socket or DIN A/V socket for connecting a video recorder (the problem of some loss of quality also arises with the video recorder). However, these sockets make it possible to connect the video signal from the computer directly to the video input of a monitor or TV receiver. With both computers this is readily done by means of a small interface. The result is far better definition and, in the case of the Spectrum, better colour reproduction.

In the Spectrum the video signal is already available at the edge connector (terminal 15 at the underside of the board, see also figure 4b). If there is no signal present, there is a wire bridge missing on the board. This is located close to TC1 and TC2 and has been drawn in the component layout of the board. If necessary, this wire bridge should be soldered in. The signal amplitude is  $1 V_{pp}$  with a d.c. offset of +2 V. The signal must be buffered if a colour monitor or TV receiver is used. This may be done, for instance, with the video amplifier described in our January 1984 issue. This amplifier is adjusted so that its output signal into  $75 \Omega$  (video input impedance of the TV receiver) is also  $1 V_{pp}$ .

Equally good results may be obtained from a simple emitter follower (see figure 12), in which the d.c. offset comes to good use! This circuit, as well as that of the video amplifier, may be used with both the Spectrum and the ZX81. As the ZX81 provides a stronger video signal than the Spectrum (about  $2 V_{pp}$ ), it is advisable to connect a  $68 \text{ ohm}$  resistor in series with the output signal to give better matching with the  $75 \Omega$  input.

The video signal of the ZX81 may be taken from pin 16 of IC1, or from a point directly connected to this and which is more accessible (for instance, D9 may be unsoldered and its anode connection used). With a bit of luck it may be possible to fit the interface in the computer case. In the Spectrum you can then take the video signal directly from the input of the ASTEC modulator at the edge of the computer board. The connecting point is situated in the centre of one of the shorter sides of the modulator and is in easy reach.

Although the video signal is always buf-

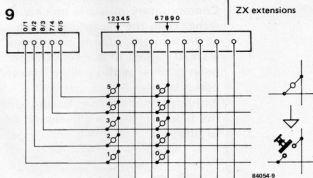

Figure 9. The keyboard connections on the Spectrum board are located underneath and to the right of the ASTEC modulator. They are used for connecting the joysticks.

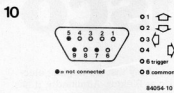

Figure 10. Common pinout of a joystick.

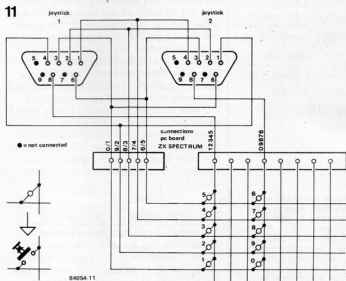

Figure 11. Wiring layout of the joystick connections to the Spectrum. Be careful when removing the ribbon cable: this must not be bent!

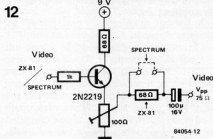

Figure 12. This simple emitter follower makes it possible to connect the video signal of the ZX computer to the video input of a monitor or TV receiver.

ferred, make sure that a terminating resistor which may have been provided in the input of the buffer stage MUST be removed. In the video amplifier from Elektor No. 9 (January 1984) this is R1. Furthermore, in this and other amplifiers, but not in the emitter follower, it is advisable to add a coupling capacitor (to provide d.c. decoupling). In the Elektor amplifier it is also beneficial, but not necessary, to change over the polarity of C2 because of the 2 V d.c. offset.

Contemporary music is quickly reaching the stage where it is the rule rather than the exception to use computers, or at least synthesizers, as 'instruments'. Many people see this as unnecessary but would like a small degree of electronicization in their music. Guitarists have long been familiar with phasers, flangers, echos, and so on but another essential member of any group, the drummer, seems quite happy with strictly mechanical drum sticks. Now, to throw the cat in among the pigeons, we have designed an electronic drum for the drummer to play with.

# disco drum

a choice of rasta, funky, or disco beats . . . or would you really prefer the monotonous 'boom-boom' of other drum synthesizers?

Nobody could say that we neglect electronic music at Elektor. Admittedly, it has been dormant for quite a while now but we felt this was necessary to give readers who are so inclined the time to come to grips with our last major work, the preset unit for the polyphonic synthesizer. The project proposed here is a more modest design; sort of a drum 'synthesizer'.

The drum sound is relatively easy to obtain as it is simply a matter of generating a sinusoidal audio signal and modulating this with an envelope having a very steep attack and an exponential decay. This gives the effect of the apparent amplitude modulation due to the fact that lower frequencies have a greater 'impact' on the ear than higher frequencies of the same amplitude.

Figure 1. The circuit of the disco drum consists mainly of an envelope generator, triggered either by calibrated pulses provided by another circuit (such as a metronome) or by the variable amplitude pulse output from the 'drum' of figure 2, and a frequency and amplitude modulated sinusoidal oscillator.

## The 2206 again . . .

The circuit diagram of figure 1 shows a design with two inputs and at least three merits: it works well, it is easy to make, and it doesn't cost a lot. The two inputs could also be considered as a further merit as they expand the range of possible applications.

The heart of this circuit is the XR 2206 function generator (IC3) which provides the sinusoidal signal. The frequency of the signal output at pin 2 is proportional to the current flowing between pin 7 and ground. This current is controlled by transistor T1 as a function of the voltage applied to its base. We will see later how this control voltage is derived. A 15 V positive pulse applied to the CLK input charges C1 almost instantaneously via D1. The discharging time across D2, which begins immediately after the falling edge of the pulse, is determined by the position of the wiper of P1.

Impedance matcher IC2 is needed to prevent the amplitude of the envelope curve, derived from the charging and discharging of C1, from being proportional to the repetition frequency of the input pulses. The envelope signal is fed to the voltage to current converter, T1, (via R3, P2, and R5) for the frequency modulation and to pin 1 of IC3 for the amplitude modulation. We were not satisfied with just the illusion of amplitude modulation so even with no trigger input the frequency of oscillator IC3 is within the audible range. If this were not the case envelopes with a small

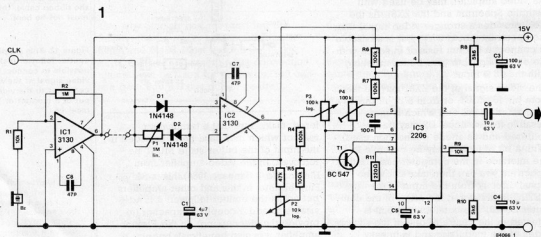



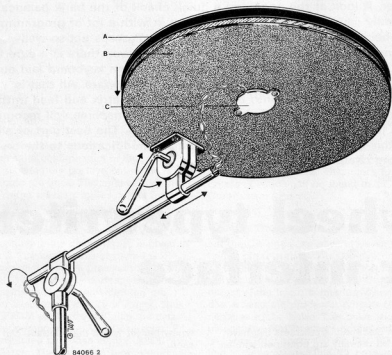

Figure 2. A 'drum pad' can be made using a piezo electric buzzer as a pressure sensor (C), an ordinary sheet of plywood (B), and a sheet of thick rubber (A). In spite of its simplicity this 'instrument' is quite sensitive to changes in the intensity of the blow.

amplitude would not even be able to trigger the oscillator, or, strictly speaking, to make it rise above the sub-audio range. The lowest frequency is set by biasing the base of T1 with P3, the minimum amplitude is decided by tuning preset P4 so that no output signal is seen from IC3 after the envelope has decayed completely.

### The two inputs

So far we have avoided mentioning the source of the trigger pulses that are applied to the input. This could be a sequencer, a rhythm box, a synthesizer keyboard, ... or any one of a long list of equipment capable of providing the (0 ... 15 V) positive pulse required by the circuit. The pulse provided by the 'Q' or 'S' outputs of the metronome published in the December 1983 issue of *Elektor* is another suitable possibility. If this is used the values of C2 and C3 in the metronome must be increased to about 470 n to ensure that the pulses are long enough to charge C1 (in the disco drum) completely. A drum would not be a drum without having something to hit. With this in mind our demon drum designer came up with the piezo-percussion instrument shown in figure 2. This consists of a disc of plywood about 20 cm in diameter, a thick sheet of rubber to cushion the blows, and a piezo electric buzzer which in this case acts as a pressure sensor. The buzzer supplies pulses to IC1 with an amplitude proportional to the intensity of the blow. This signal should only be used when a fre-

### 3

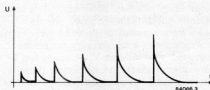

quency modulation proportional to the intensity of the blow is desired, as indicated by the different envelopes in figure 3. A 3130 was chosen for IC1 because, at rest, the output of the amplifier must return to zero to enable C1 to discharge. In the same vein the leakage current of C1 is quite important; the smaller it is the better. For this reason a pair of 2  $\mu$ F non-electrolytic capacitors in parallel are to be favoured over a single 4.7  $\mu$ F electrolytic. When we finished our electronic drum we decided that the best way to test it was to ask some famous drummer to try it out. No expense was spared (!) and we eventually managed to get hold of the resident group at the Muppet Theater, Doctor Teeth and his Electric Mayhem Orchestra. The drummer, Animal, sat in front of the drum and then it seemed as if all Hell broke loose. A couple of hours later Doctor Teeth came to talk to us. 'Hey, man, I'm sorry about your drum but Animal says it not only sounds good, it tastes good as well!'.

Figure 3. Just as the calibrated pulses supplied by a metronome, for example, provide envelopes with a constant amplitude, the pulses given by the drum pad in figure 2 result in envelopes whose amplitudes are proportional to the intensity of the blows.

an inexpensive  
high quality  
computer  
printer

# daisywheel typewriter printer interface

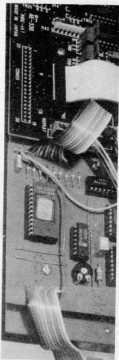

Table 1. An example of how the eight lowest address lines of EPROM IC1 are encoded.

Sooner or later every serious computer user feels the need for a printer. A look at the price and a quick check of the bank balance generally causes a state of gloom to set in with a lot of programming time being spent humming verses of Blaise Pascal's not-so-well-known ode 'Oh, for a little printer'. Now, however, there is a cure for this condition. Most electronic typewriters have a keyboard laid out as a matrix which is controlled by means of software. All that is needed, then, is to tap into the output of the matrix and feed in the codes for the characters to be printed and the machine will recognize them just as if the same key has been pressed. The best part of all is that this does not even require any drastic modifications to the existing circuit.

Certain electronic typewriters that have appeared recently are equipped with an interface for a computer (such as an RS232C, Centronics, IEC, and so on). These are of no interest to us as they do not need any adapting, provided the interface chosen is the right one. There are others which, although electronic, are not intended to be controlled by a micro computer. Many of these, however, have a sufficiently good quality to price ratio to make them a sound proposition for modification to a high-quality printer for a computer system, even if it already has a dot-matrix printer. First, of course, there is the little matter of an interface, but that need no longer be a worry. We have designed a Centronics interface for a certain type of electronic typewriter and it is versatile enough so that it could relatively easily be modified for other types of machines.

The machine we chose is the Smith Corona EC1100 portable electronic typewriter, mainly because it is a simple, robust, machine with a good quality to price ratio and it is quite freely available. It is a daisywheel machine and, as we have already made clear, it serves as a reference here rather than being the only

typewriter for which this interface can be used.

## Simulating the matrix decoding

As figure 1 shows, the keys are arranged in a matrix of  $8 \times 9$  lines which the processor in the typewriter (an 8039) will decode by sweeping it with a 2 ms positive pulse. When a key is pressed the pulse applied to one of the input lines of the matrix (columns  $Y_0 \dots Y_8$ ) reappears at one of the output lines (rows  $A_0 \dots A_7$ ) and the cross-reference thus obtained tells the processor which key was pressed. Our modification must therefore place the code corresponding to the character to be printed on output lines A. To do this the ASCII code for the character must be combined with the input code to the matrix ( $Y_0 \dots Y_8$ ) generated by the processor to form an EPROM address containing the exact same data that would be present on lines  $A_0 \dots A_7$  if the key for the same character were pressed. This means that the keyboard does not have to be modified at all and can be used normally. An example of this procedure (for the ASCII character 'P') is given in table 2 and we will return to this later.

Moving on to the circuit diagram of figure 2, we see that only a few ICs are needed. The most essential one is, of course, IC1, a 2716 EPROM, whose data outputs are connected to the  $A_7 \dots A_0$  lines of the matrix. The diodes,  $D_1 \dots D_8$ , are included to ensure that the existing keyboard can still be used when the interface is connected. Address lines  $A_{10} \dots A_4$  receive the seven-bit ASCII code for the character that is to be printed from the computer via its Centronics output ( $D_6 \dots D_0$ ). The four remaining address lines,  $A_3 \dots A_0$ , receive the code generated by IC8 (a 10 to 4 line BCD encoder). This is the BCD equivalent of the input code to the matrix ( $Y_7 \dots Y_0$ )

Table 1

Matrix									EPROM				
Y7	Y6	Y5	Y4	Y3	Y2	Y1	Y0		A3	A2	A1	A0	
0	0	0	0	0	0	0	1		1	1	1	1	F
0	0	0	0	0	0	1	0		1	1	1	0	E
0	0	0	0	1	0	0	0		1	1	0	1	D
0	0	0	1	0	0	0	0		1	1	0	0	C
0	0	1	0	0	0	0	0		1	0	1	1	B
0	1	0	0	0	0	0	0		1	0	1	0	A
1	0	0	0	0	0	0	0		1	0	0	1	9
1	0	0	0	0	0	0	0		1	0	0	0	8
A7	A6	A5	A4	A3	A2	A1	A0						

Table 2

EPROM IC1: addresses										EPROM IC1: data								
A10	A9	A8	A7	A6	A5	A4	A3	A2	A1	A0	D7	D6	D5	D4	D3	D2	D1	D0
(0)	1	0	1	0	0	0	0	1	0	1	0	0	0	1	0	0	0	0
ASCII code 50Hex ('P')						Y2 (0AHex)				line A4 of the matrix is active								

that is inverted by N5...N12 so that the 40147 will accept it. This conversion is indicated in table 1, the left side of which contains the configuration of the matrix lines showing the positive pulse (the '1') sweeping the lines. The right side of the table is the resultant codes output from IC8, which are, of course, in negative logic (so '1' is 0 V and '0' is +5 V). A specific example, outputting the code corresponding to the character 'P', is given in table 2. The key for this character is number 29 and when pressed it links Y5 to A4. The BCD code corresponding to the matrix configuration when the processor is scanning line Y5 is A<sub>4</sub>HEX. Thus the EPROM address containing the data corresponding to the ASCII character 'P' is constituted by codes 50HEX (ASCII 'P') and A<sub>4</sub>HEX. The data must be programmed such that line A4 in the matrix is activated; i.e. with 10HEX.

The second EPROM, IC2, is needed for a few specific functions: shift, keyboard II (KBII), and carriage return (CR). The SHIFT A line is activated every time an ASCII code output by the micro computer corresponds to a character in the upper

register of the typewriter keyboard. Line KBII can only be activated by the processor when line Y8 is active because of the presence of N3. This signal gives access to several special characters, further details of which can be found in the Smith Corona user's manual.

### Timing the signals

For the CR signal we must move on to the timing of the signals. We also have to start by taking a step backwards to the moment when the data appeared at the Centronics output of the micro computer. When the data is valid the processor outputs a negative strobe pulse. This pulse triggers monostable MMV1 whose output pulse (set with P1) is about 100 ms. The BUSY line is then activated, via N2, preventing the micro computer from sending any new data to the Centronics port. This results in a printing speed of about nine characters per second. Simultaneously MMV2 produces a pulse of about 50 ms which delays the enabling (OE) of IC1 so that the codes for SHIFT, KBII, and CR given by IC2 always appear a fraction of a

daisywheel typewriter  
printer interface

Table 2. An example of how the EPROM is addressed for a given ASCII code (for the character 'P'). The address is 50HEX and the data is 10HEX.

Table 3

A0: 01
A1: 02
A2: 04
A3: 08
A4: 10
A5: 20
A6: 40
A7: 80

Table 3. These are the only matrix output codes possible as only one line at a time can be active.

1

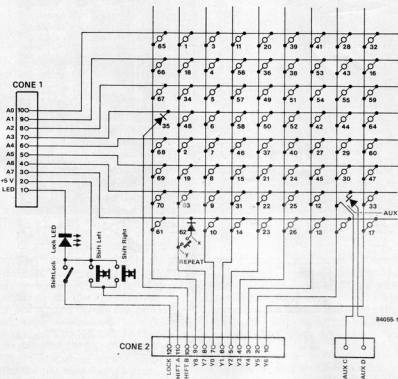

Figure 1. The keyboard matrix is connected to the main printed circuit board of the Smith Corona EC 1100 by means of two connectors: CONE 2 where we find the pulse that sweeps the keyboard to detect any key that is pressed, and CONE 1 to which we apply a code simulating the pressing of the key corresponding to the character to be printed. These two connectors are easily located on the typewriter's printed circuit board.

second before those output by IC1. The CR pulse poses a particular problem as no character may be either received or printed while the carriage is on the return journey — unlike a printer the typewriter is not bidirectional. This is why the CR signal resulting from the  $\text{0DHEX}$  code applied to IC1 and IC2 controls a third monostable to activate the BUSY line for the duration of the carriage return. Capacitor C4 in the time base of IC7 charges to a certain extent depending on the time between two CR pulses so that the duration of the carriage return is proportional to the number of characters in the line ended by the  $\text{0DHEX}$  code. The typewriter automatically performs a line feed ( $\text{0AHEX}$ ) after a carriage return. Computers generally follow a  $\text{0DHEX}$  (CR) with a  $\text{0AHEX}$  (LF) which gives two line feeds instead of one unless the  $\text{0AHEX}$  code is suppressed in EPROM IC1, as we have done. This saves the trouble of having to suppress it in the computer. As we did not want to lose the line feed function completely it is assigned the code  $\text{0FHEX}$  (CTL-O). The RC network made up of R7 and C10 is used to convert the BUSY signal (active logic high) to an  $\text{ACK}$  signal (active on the falling edge) which some Centronics interfaces require.

### Construction and fitting

Building this project is greatly simplified by using the printed circuit board design shown in figure 3. As usual, it is a good idea to fit the wire links first to ensure that they will not be forgotten. The EPROMs should be mounted in good quality sockets, especially if the typewriter used is not the EC 1100 as these ICs will then probably have to be removed several times until the coding is fully correct. As the layout of the printed circuit board indicates, the mounting point have been provided to be compatible with the case of the typewriter. To connect the interface to the typewriter a pair of 10 and 12 pin male and female connectors will be needed, as shown in figure 4. These are not strictly essential, however, as the cable could simply be soldered at the appropriate points on the Smith Corona's printed circuit board, marked CONE 1 and CONE 2. The type of connection used for the Centronics input is left to your own initiative as it must be modified to what is needed.

The supply voltage for the interface is tapped from the typewriter itself (pin 2 of CONE 1 = +5 V). A ground connection must be made between '0' near C7 on the printed circuit board of figure 3

Figure 2. The Centronics interface is branched parallel to the existing keyboard and simulates a key being pressed by applying the pulse that appears at one of the input lines (Y0 . . . Y8) of the matrix to one of the output lines (A0 . . . A7). Potentiometer P1 should be adjusted to give the maximum possible printing speed without the typewriter failing to print any of the characters properly. The interference threshold can be greatly improved by connecting lines D0 . . . D6 in the Centronics socket to earth via 10 k resistors. The interface is then 'off' when there are no signals present.

2

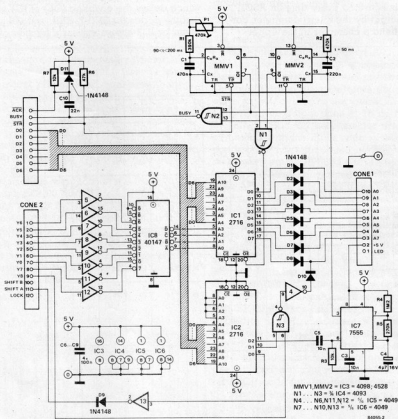

MMV1, MMV2 = IC3 = 4098, 4528  
 N1 . . . N3 = 1/2 IC4 = 4093  
 N4 . . . N6, N11, N12 = 1/2 IC5 = 4049  
 N7 . . . N10, N13 = 1/2 IC6 = 4049

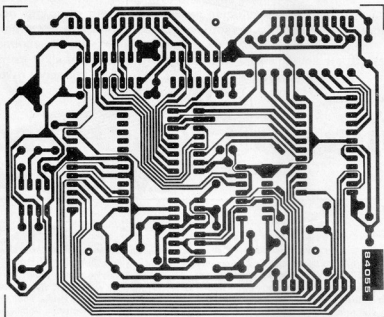

## Parts list

## Resistors:

R1 = 390k  
 R2 = 470k  
 R3, R7 = 10k  
 R4 = 1M2  
 R5 = 270k  
 R6 = 47k  
 P1 = 470k preset

## Capacitors:

C1 = 470n  
 C2 = 220n  
 C3, C5 = 10n  
 C4 = 4 $\mu$ 7/16 V  
 C6... C9 = 100n  
 C10 = 22n

## Semiconductors:

D1... D11 = 1N4148  
 IC1, IC2 = 2716  
 IC3 = 4098, 4528  
 IC4 = 4093  
 IC5, IC6 = 4049  
 IC7 = 7555  
 IC8 = 40147

## Miscellaneous:

Smith Corona EC 1100  
 electronic daisywheel  
 typewriter

## Optional:

2.5 mm connectors, one off  
 each male 10 pin, female  
 10 pin, male 12 pin, female  
 12 pin, such as Molex  
 5267-10a, 5264-10,  
 5267-12a, 5264-12.

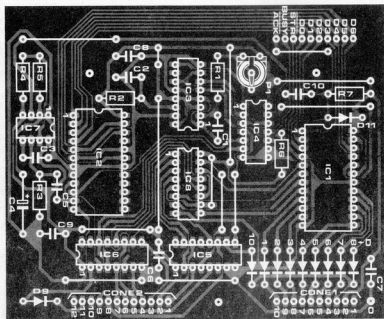

Figure 3. The printed circuit board was carefully designed so that it can be mounted in the machine beside the existing board, so it simply has to be fixed in position with three screws. Links to CONE 1 and CONE 2 could be made in the manner indicated in figure 4. Don't forget the connection to ground.

and the GND point near CONE 6 (the supply connector). The current consumption of the interface is about 150 mA, which the existing supply can provide without any problem.

When you pick up the EC 1100 to start to modify it one of the first things you will note is the lack of any type of screw holding the two halves of the case together. As with most such problems, separating the halves of the case to get at

the innards is easy once you know how. The top part of the case is fitted with several plastic clips which mate with grooves in the bottom half so to separate the two sides of the top must be pressed and lifted to release the clips.

### Programming the EPROMs

We have purposely left the programming of the EPROMs until last. This part of the

Figure 4. Connection to the Centronics interface is simplified by using the same type of connectors as the machine already uses for CONE 1 and CONE 2. The new connectors are mounted on a piece of veroboard to which the cable for the interface is also connected. The diagram is duplicated once with a pair of 10 pin connectors and once with 12 pin connectors.

4

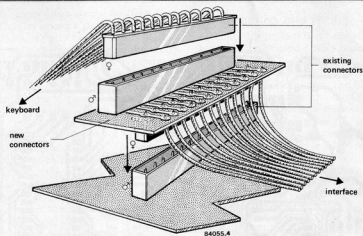

Table 4.

key no.	address	data	05	38B	20	7	35F	10	51	43C	04	24	54C	20
31	21E	40	9	3CF	40	8	36F	20	38	44C	02	26	56C	80
4	22F	02	14	3DE	80	9	37F	40	22	450	40	52	56C	08
6	23F	08	10	38F	80	10	38F	80	39	46C	01	21	57D	20
6	24F	08	30	3FA	20	11	38E	01	40	47C	10	50	58D	08
58	25E	08	56F	10	08E	20	41	488	01	25	59C	40		
9	26F	40	46	40E	10	208	40	27	498	10	49	5AD	04	
10	27F	80	7	608	40									
11	28E	01	4	0F9	20	31	58E	40	43	48A	02			
12	29B	40	009	04	46	50E	10	44	4CA	08				
3	2AF	01	089	10	3	7CF	01	55	4DA	04				
3	2AF	01	7F9	02	13	78B	80	54	4E8	04				
56	2CE	02	12	30B	40	13	7DB	80	28	4FA	01*			
30	2DA	20	3	31F	01	32	7E9	01	29	50A	10			
57	2EE	04	4	32F	02	32	6E9	01	20	51D	01			
5	2FF	04	5	33F	04	36	41D	02	23	52D	80			
45	3AB	20	6	34F	08	53	42B	02	37	53D	10			

Table 4. The contents of EPROM IC1.

Table 5. This is the data stored in EPROM IC2. All addresses not mentioned contain 01HEX.

D000: 01	D100: 01	D200: 01	D300: 01	D400: 00	D500: 00	D600: 01	D700: 01
D010: 01	D110: 01	D210: 00	D310: 01	D410: 00	D510: 00	D610: 01	D710: 01
D020: 01	D120: 01	D220: 00	D320: 01	D420: 00	D520: 00	D620: 01	D720: 01
D030: 01	D130: 01	D230: 02	D330: 01	D430: 00	D530: 00	D630: 01	D730: 01
D040: 01	D140: 01	D240: 00	D340: 01	D440: 00	D540: 00	D640: 01	D740: 01
D050: 01	D150: 01	D250: 00	D350: 01	D450: 00	D550: 00	D650: 01	D750: 01
D060: 01	D160: 01	D260: 00	D360: 01	D460: 00	D560: 00	D660: 01	D760: 01
D070: 01	D170: 01	D270: 00	D370: 01	D470: 00	D570: 00	D670: 01	D770: 01
D080: 01	D180: 01	D280: 00	D380: 01	D480: 00	D580: 00	D680: 01	D780: 01
D090: 01	D190: 01	D290: 00	D390: 01	D490: 00	D590: 00	D690: 01	D790: 01
D0A0: 01	D1A0: 01	D2A0: 00	D3A0: 01	D4A0: 00	D5A0: 00	D6A0: 01	D7A0: 01
D0B0: 01	D1B0: 01	D2B0: 00	D3B0: 01	D4B0: 00	D5B0: 01	D6B0: 01	D7B0: 00
D0C0: 01	D1C0: 01	D2C0: 01	D3C0: 02	D4C0: 00	D5C0: 01	D6C0: 01	D7C0: 02
D0D0: 05	D1D0: 01	D2D0: 01	D3D0: 01	D4D0: 00	D5D0: 01	D6D0: 01	D7D0: 01
D0E0: 01	D1E0: 01	D2E0: 01	D3E0: 02	D4E0: 00	D5E0: 00	D6E0: 01	D7E0: 00
D0F0: 01	D1F0: 01	D2F0: 00	D3F0: 00	D4F0: 00	D5F0: 01	D6F0: 01	D7F0: 01

5

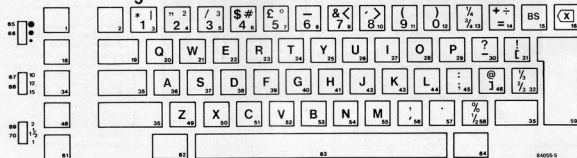

Figure 5. The keys have the normal QWERTY layout and some have three functions, which are dealt with in the user's manual. The numbering of the keys corresponds to that in the matrix of figure 1.

project may seem somewhat illogical due to the layout of the keys and their positions in the matrix (as figure 5 shows). In EPROM IC2 only one sixteenth of the memory space is filled as the first four address lines are not used. The table corresponding to the contents of EPROM IC1 is arranged according to the ASCII codes (which are not indicated). These EPROMs

can be programmed by the user himself or may be purchased pre-programmed from Technomatic Ltd.

Finally, a quick recap of the commands recognised and executed by the machine: CTL-K (0BHEX) = VT, CTL-H (08HEX) = BS, DEL (7FHEX) = erase, and CTL-O (0FHEX) = LF instead of the usual CTL-J.

The anemometer featured in our November 1983 issue contains a memory which stores the minimum and maximum windspeeds measured in the form of positive analogue voltages. A simple addition can make this memory store negative values also. The resulting maximum and minimum memory is suitable for a number of applications. As an example of these we describe an electronic version of Six's famous thermometer; other possibilities are left to your own ingenuity and imagination.

maximum and minimum memory

# maximum and minimum memory

The amateur meteorologists among you where no doubt delighted with the anemometer and wind direction indicator published in our November 1983 and February 1984 issues respectively. Your weather station can now be augmented with an electronic maximum and minimum thermometer. Such a thermometer, using alcohol instead of electronics, was invented by the British physicist Six. It enables the recording of both the highest and the lowest temperatures reached since the thermometer was set.

our November 1983 issue.

The memory of the anemometer stores two voltages between 0 V and 1 V, of which one represents the highest recorded windspeed, and the other the lowest. As these values are continuously compared with the current windspeed, they are always up to date. The attraction and usefulness of such circuits is their facility for retaining analogue values for a long time. The actual storing takes place in digital form in a binary counter. Before the content of the store can be compared with the current value, it is changed into an analogue voltage by a digital to analogue converter. Whether the memory is updated or not depends on the result of the comparison.

analogue voltages remembered . . . . . digitally!

## The circuit

Only a synopsis of the circuit is given here as a detailed description appeared in

1

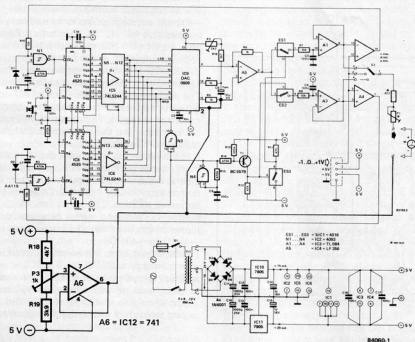

Figure 1. The circuit of the memory which is almost identical to that of the anemometer. The earth potential at pins 2 of IC3 and 3 of IC4 respectively is shifted by A5 which enables negative voltages to be processed.

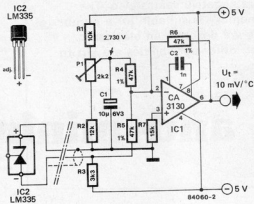

Figure 2. The temperature sensor in which P1 sets the output voltage at 0 V for 0 °C. The adjustment terminal of the LM335 is not used.

The memory must, however, be expanded to make it usable with negative input voltages. The temperature sensing unit can be calibrated to give an output voltage of 0 V at an ambient temperature of 0 °C. Temperatures above 0 °C result in positive voltages, those below in negative voltages. In the circuit described, the input voltage range can be set between -1 V and +1 V.

The circuit of the augmented memory is given in figure 1, which shows that the additional stage consists of an operational amplifier, A6, and associated components. The opamp, which functions as a voltage follower with unity gain, is powered by the existing symmetrical ±5 V supply. The values of R18, P3, and R19 are necessary to

enable the output voltage of A6 to be preset somewhere between 0 V and -1 V. The actual value preset by P3 is somewhat more negative than that representing the lowest expected temperature. The function of A6 is to shift the earth potential of the D/A converter IC3, current/voltage converter A5, and the measuring instrument to the preset value.

The other addition is, of course, the temperature sensor, the circuit of which is shown in figure 2. The sensing unit, IC2, is a type LM335 which converts changes in temperature into voltage variations. Its temperature/voltage slope is 10 mV/K in the range -40 °C ... +100 °C. The output of IC2 is fed to opamp IC1 which arranges for the output voltage to be 0 V at an ambient temperature of 0 °C. Output voltage  $U_t$  is then related to the ambient temperature at 10 mV/°C provided that the output of A6 can really go down to -1 V. This is guaranteed as long as R4, R5 and R6 are high-stability (1%) metal-film resistors, and P3 has been adjusted correctly.

### Construction and calibration

The printed circuit used is identical to that of the anemometer (EPS 83103-1), which is constructed as described in the anemometer article, with the exception of the wire bridge alongside C9 and R16. Instead of this, break the earth connections of pin 2 of IC9 and pin 3 of IC4 and wire these pins, together with junction C9/R5, to the output (pin 6) of IC12. The circuit around this opamp, and, for that matter, the one of the temperature sensor, is so small that it is best built on a small piece of wiring (Vero) board.

Start the calibration by adjusting P3 so that the output of A6 lies between -1 V and 0 V as required; normally, this will be -400 mV, corresponding to an ambient temperature of -40 °C. Then adjust P2 to give +1 V (+100 °C), measured with a digital multimeter, at the junction R16/R4/C9. It may be necessary to enlarge R16 slightly to achieve this result. The setting of P1 and the value of R17 are both dependent on the measuring instrument and its scale. They have to be set/computed on the assumption that the voltage at 'f' is 10 mV/°C.

It is interesting to connect a digital multimeter between 'f' and earth, because that instrument can read negative voltages. A temperature below 0 °C will therefore be indicated as such. The same can, of course, be achieved with a centre-zero meter which has been calibrated from -40 °C to +40 °C.

Finally, adjust P1 in the sensing circuit to give a voltage of 0 V at pin 6 of IC1 at an ambient temperature of 0 °C. If you want to avoid working with ice cubes, you may adjust P1 to give a voltage of 2.730 V at its wiper, measured with a digital voltmeter.

Figure 3. Only a few modifications are necessary to the printed-circuit board: two breaks and three extra connections. The wire bridge along C9 and R16 should be omitted.

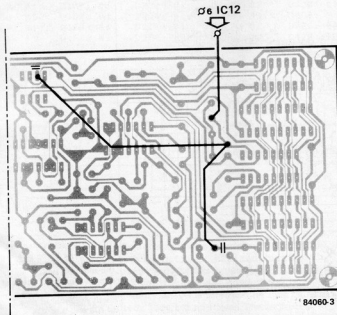



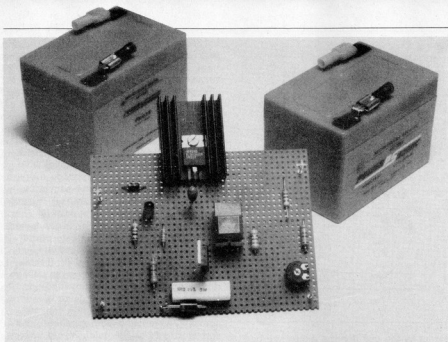

# lead-acid battery charger

The lead-acid battery has improved so much in recent years that it can often be a good and less expensive substitute for the popular NiCad battery. A special charger is required, however, as the lead-acid battery must be charged at a constant voltage rather than constant current. The charger described in this article uses one of two charging voltages automatically selected depending on the current flowing through the battery. In this way we get an optimal compromise between short charging time and long battery life.

What springs to most people's minds when the lead-acid battery is mentioned is the automotive version. That is a heavy box full of acid providing the energy to start the car and needing occasional maintenance to keep it healthy. Lead-acid batteries are also used for a multitude of other applications, such as large torches, small cordless household appliances, models, and, of course, as an emergency supply for important equipment in case of mains failure.

The modern lead-acid battery is available in all shapes and sizes. There are even gas-tight versions enabling the lead-acid battery to be used in many applications as a replacement for the commonly used NiCad battery.

The lead-acid battery has a few important advantages over its NiCad counterpart, especially if the current requirement is fairly high. Its energy capacity is much greater than the NiCad's, and the same can be said of its output. The lead-acid battery's greatest strength is the large number of charging and discharging cycles possible relative to the low purchase price (compared to the NiCad). The lead-acid battery must be charged in a completely different way than the NiCad

equivalent. The latter requires a constant charging current whereas the former needs a constant voltage. The battery then controls the charging current itself so that the minimum of gases are generated. The difference between these two methods of charging is shown in figure 1.

The charging voltage of a lead-acid battery is largely responsible for its lifespan. It should be noted, in passing, that the life of a completely discharged lead-acid battery is only a few weeks, so it is a very bad idea to simply leave a battery discharged. Using a high charging voltage gives a short charging time but also a short lifespan, while a low charging voltage results in a long charge time and long lifespan. To give you an idea of the values we are talking about here, a General Electric gas-tight lead-acid battery has a lifespan of three years with a 'high' charging voltage of 2.45 V per cell. It is then charged to 95% of nominal capacity in eight hours. A 'low' voltage charge at 2.30 V per cell increases the lifespan to eight years (provided the battery is continuously connected to the charger) but the time needed to charge is then fifteen hours (see figure 2). The importance of the charging voltage is ap-

a two-stage design to enable fast charging without reducing the battery's lifespan

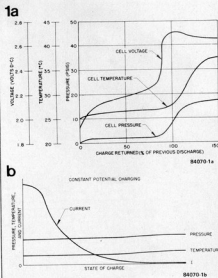

Figure 1. Graph a shows the curves for the voltage, internal pressure and temperature of a lead-acid battery charged at constant current. If a constant voltage charge is used (characteristic b) the curves for pressure and temperature are much better as no over-charging then occurs.

parent by the fact that the difference between the two voltages is only 0.15 V. The lead-acid battery charger must make some sort of compromise between charging time and lifespan. The voltage at the last part of the charging cycle is especially important for the battery's lifespan. If the current is too large it will cause a deterioration in the lead grid to which the active part of the battery is fixed. A lower charging voltage will make the current correspondingly smaller so there will be less deterioration. This is particularly important if the battery is nearly always connected to the charger. The solution for this is a charger that adapts the voltage to the current flowing through the battery. The lead-acid battery charger described here uses a two-stage system in which the charger itself switches from high to low voltage when the charging current falls below a previously set value. The circuit is not only suitable for normal charging but can also be used for applications where the battery is generally on stand-by.

### The charger

Even though the operation may sound somewhat complicated the circuit is quite simple and, as figure 3 shows, only contains 16 components. It is based on an

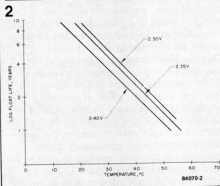

Figure 2. This graph clearly shows the effect of charging voltage on the battery's lifespan.

LM 317 voltage regulator (IC1) which ensures that the voltage at the output is constant. This voltage is initially defined by voltage divider R5/R6 + P2. The low voltage that decides the current in the second part of the charging cycle is set with preset P2.

A thyristor and a resistor (and a normally closed push button) are connected parallel to R6 and P2. When the thyristor conducts R4 is switched in parallel with R6 + P2 so that the output voltage drops somewhat (this is the second part of the charging cycle). The moment that Th1 triggers depends on the output current. This is the reason why resistor R7 is connected in the zero voltage line. The gate of the thyristor is connected to the output voltage of IC1 via R2, R1, and P1. If the charging current is fairly large the voltage drop across R7 keeps the potential difference between gate and cathode too low to trigger the thyristor (the voltage across R7 is negative with respect to that across R1 + P1 so the gate-cathode voltage is  $U_{R1} + P1 - U_{R7}$ ).

After a certain length of time the battery is charged so far that the current has fallen to the value set with P1. The thyristor is then triggered, R4 is connected in parallel with R6 + P2, and the output drops to the low voltage. As we have already seen, the difference between high and low voltage is quite small at about 0.15 V per cell. When the output voltage is the low value LED D3 will light. In order to prevent the thyristor from being triggered as soon as the circuit is powered up, but with the battery not yet connected, a push button, S1, is included. After connecting the mains supply and the battery, S1 is pressed causing the high voltage to appear at the output and a 'large' current to flow through R7. The push button is then released and Th1 remains off as long as the current through R7 stays high enough. The charging current can be measured by connecting a meter in parallel with R7. This is indicated with dotted lines in figure 3.

### Calibration and use

This circuit is easily constructed on a piece of Veroboard. Some of the components in the diagram have two values, one of which (marked with an asterisk) should be used for the 12 V version and the other for a 6 V version of the circuit. The IC must be mounted on a heatsink as it tends to get rather warm. The value of resistor R7 depends on the capacity of the batteries that are to be charged, as we will see shortly.

The circuit must be supplied with a rectified and smoothed voltage of at least 3 V more than the output voltage from the regulator. The supply used must be able to provide at least 1/10 of the current capacity of the battery but this should not be more than about 1.5 A as this is the value at which the LM 317's internal current limiting comes into action. This cur-

rent limiting does depend on the exact type of regulator used; for the LM 317K or LM 317T it is 1.5 A but for LM 317H or LM 317M the current is limited at 0.5 A. The value of resistor R7 is calculated from the formula:  $R7 = 0.3 V / I_{switching}$ . The switching current (or, the current at which the circuit switches from high to low voltage charging — which seemed a bit long to put in a formula) can be set to any value. A good compromise would be a current that is 1/10 or 1/20 of the nominal battery capacity (see figure 4).

The circuit must now be calibrated with the power switched on but without any battery connected. If everything is working the thyristor will conduct and D3 light. Connect an accurate, preferably digital, meter onto the output and set P2 until the meter reads exactly the number of cells multiplied by 2.3 volts. Three cells need 6.90 V and six cells give a value of 13.8 V. Press S1 and keep it pressed. Now measure the output voltage, which must be the number of cells times 2.45 volts (7.35 V for 3 cells and 14.7 V for 6 cells). If the voltage is not close to this value the resistance of R4 may have to be changed and P2 then readjusted. The final adjustment is to set the switching point with preset P1. The most obvious method of doing this is to connect a partly discharged battery to the charger. Rotate the wiper of P1 completely towards R1 and then press S1 to start high-voltage charging. Measure the current through the battery (by connecting a voltmeter across R7;  $I = U/R7$ ) and check from time to time, every half hour or so, whether the current has dropped to the desired value. When this point is reached P1 must be trimmed until the LED just lights. The charger is then ready for use.

Using the circuit is very straightforward:

- Connect the supply to the charger and switch on. The LED should light.
- Connect the battery to the output of the charger.
- If fast charging is desired press S1. The LED is then not lit.
- After a certain length of time D3 lights to indicate that the switching point has been passed and that the charger is charging at normal speed.

Finally, a note about the characteristics shown in this article. In principle these only apply for General Electric lead-acid

#### 4

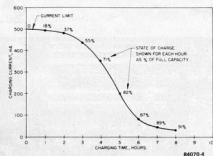

#### 3

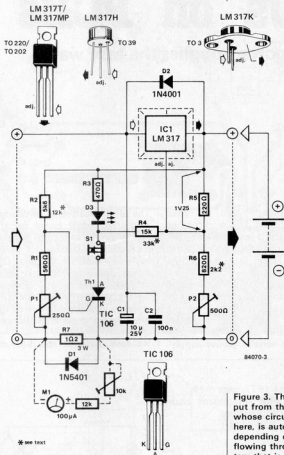

lead-acid battery charger

Figure 3. The voltage output from the charger, whose circuit is shown here, is automatically set depending on the current flowing through the battery that is being charged. If M1 is included the 10 k preset must be trimmed so that M1 reads the same value as an ammeter connected in either the 'O' or '+' line to the battery under charge.

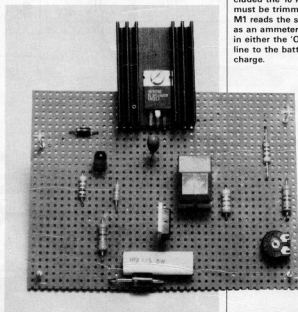

batteries but most similar batteries have the same sort of characteristics. They are only included in this article to indicate the type of curves that can be expected. Literature: *The sealed lead battery handbook* by General Electric

Figure 4. This gives an idea of the charging current when a battery is charged at a constant voltage. The charger used here had current limiting set at 500 mA, which is why the characteristic begins where it does.

# PSUs on PCBs

## building power supplies the easy way

The printed circuit board has been completed and tested. It is working fine and now ready to fit into the case. But what about the power supply? Is it still that 'Christmas tree' tacked onto the transformer terminals? It happens to most of us (or so it would seem) judging from the comments in our reader's letters. All too often the power supply is forgotten until the last moment, especially if the test equipment includes a variable power supply.

The ideal situation is, of course, to have a printed circuit board for the power supply as well as for the project and this is possible via the Elektor Print Service. In many Elektor circuits the power supply has been included on the main printed circuit board. However, there are a number of others that are entirely separate and the purpose of this article is to group these together as a handy reference.

We have included the most useful cir-

cuit diagrams and it will be apparent that many can be modified to suit specific requirements. The 78\*\* regulators are interchangeable provided the transformer can supply 3 volts above the regulated voltage (e.g. the 7815 requires 18 V from the transformer). Remember also that the working voltages of the capacitors must be adequate (otherwise they could become momentary action switches - once!).

### +5 V 500 mA

Issue E26, June 1977, page 6-25.

This circuit with component changes will suit many applications.

Board number EPS 9448-1.

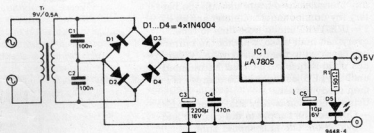

#### Parts list

##### Resistors:

R1 = 150 Ω

##### Capacitors:

C1, C2 = 100 n  
C3 = 2200 µ/16 V  
C4 = 470 n  
C5 = 10 µ/6 V

##### Semiconductors:

D1, D2, D3, D4 = 1N4004  
DE = LED e.g. TL 209  
IC1 = µA 7805 or LM 129

##### Miscellaneous:

Tr = mains transformer, 9 V,  
0.5 secondary

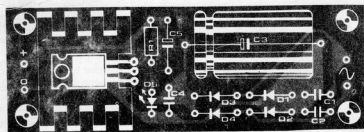
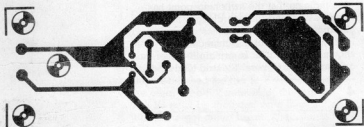

### +15 V 250 mA and -15 V 250 mA

Issue E42, October 1978, page 10-38.  
Originally designed for the Elektor TV scope but very useful where op-amps are used.

Board number EPS 9968-5a.

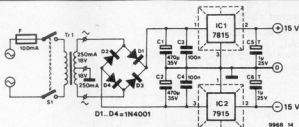

#### Parts list

##### Capacitors:

- C1, C2 = 470  $\mu$ /35 V
- C3, C4 = 100 n
- C5, C6 = 1  $\mu$ /25 V tantalum

##### Semiconductors:

- IC1 = 7815
- IC2 = 7915
- D1... D4 = 1N4001

##### Miscellaneous (not on p.c. board proper, see figure)

- Tr1 = mains transformer, 2 x 18 V/250 mA
- S1 = double-pole mains switch
- F1 = fuse, 100 mA

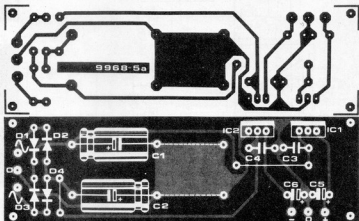

### +15 V 1 A

Issue E31, November 1977, page 11-37.  
Board number EPS 9218b, limited stocks still available, price £ 1.05.

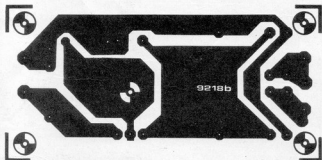
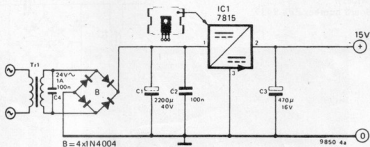

#### Parts list

##### Capacitors:

- C1 = 2200  $\mu$ /40 V
- C2, C4 = 100 n
- C3 = 470  $\mu$ /16 V

##### Semiconductors:

- IC1 = 7815
- B = 4 x 1N4004

##### Miscellaneous:

- Transformer with 24 V/1 A secondary



# +30 V 2 A and -30 V 2 A

Issue E18, October 1976, page 10-45.

Outputs independently variable.

Board number EPS 9004.

## Parts list

### Resistors:

- R1, R2 = 47  $\Omega$
- R3, R4 = 0.33  $\Omega$ /2 W
- R5 = 71 k $\Omega$
- R6 = 3k3, 1 W
- P1 = 100 k lin.
- P2 = 47 k lin.

### Capacitors:

- C1, C2 = 4700  $\mu$ , 35 V
- C3, C4 = 1 n
- C5, C6 = 100  $\mu$ , 35 V

### Semiconductors:

- IC1 = RC 4194 (Raytheon)
- T1 = TIP 2955
- T2 = TIP 3055
- T3, T4 = BC 140-10, 2N1711
- D1 = LED
- B1 = B80C5000 (80 V, 5 A)

### Various items:

- Tr = mains transformer,  
2 x 22 V/2 A

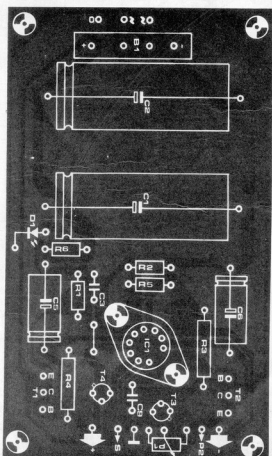
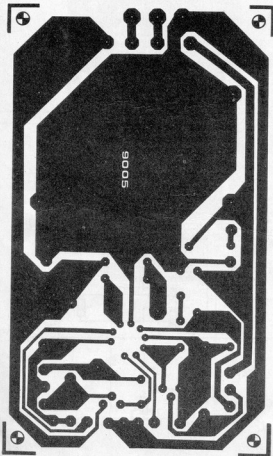
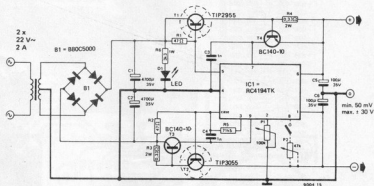

+0...10 V 300 mA

Issue 27/28, July/August 1977, page 29.

Board number EPS 77059.

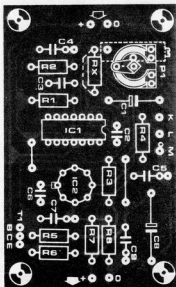
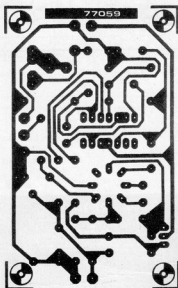
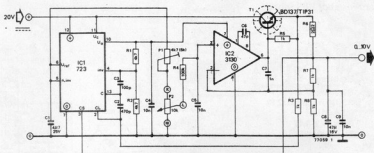

+5 V 3 A and -12 V 500 mA

Issue E35, March 1978, page 3-09.

Originally designed for the SC/MP and would suit many microprocessor systems.

Board number EPS 9906.

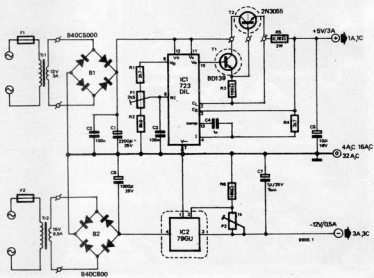



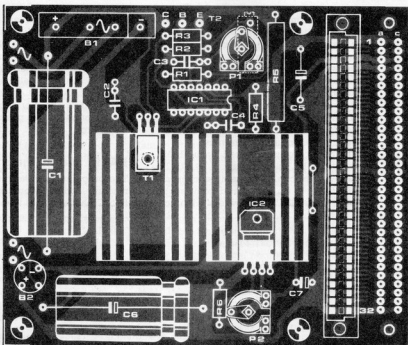
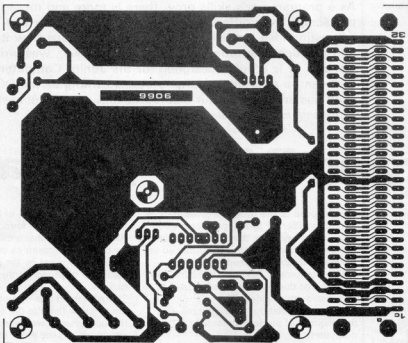

#### Parts list

##### Resistors:

R1, R4 = 2k7  
 R2 = 8k2  
 R3 = 100  $\Omega$   
 R5 = 0.18  $\Omega$ /2 W (see text)  
 R6 = 180  $\Omega$   
 P1 = 2k5  
 P2 = 1 k

##### Capacitors:

C1 = 2200  $\mu$ /25 V (see text)  
 C2, C3 = 100 n  
 C4 = 1 n  
 C5 = 10  $\mu$ /16 V  
 C6 = 1000  $\mu$ /25 V  
 C7 = 1  $\mu$ /25 V tantalum

##### Semiconductors:

IC1 = 723  
 IC2 = 79G  
 T1 = BD 137, BD 139  
 T2 = 2N3055  
 B1 = B40 C5000 40 V  
 5 A bridge rectifier (see text)  
 B2 = B40 C800 40 V  
 800 mA bridge rectifier

##### Miscellaneous:

Tr1 = Transformer 12 V,  
 3...4 A secondary  
 (see text)  
 Tr2 = Transformer 15 V,  
 0.5 A secondary (see text)  
 F1, F2 = 300 mA slo blo fuse

As a programmer's skills grow there is more and more temptation to use scraps from different programs to make a new one. This is an interesting idea but it is not immediately obvious how it could be put into practice. The program given here, however, was written to do just this. It is a utility designed for the Junior Computer with DOS that can be adapted for other systems as long as the DOS (or BASIC) used has an input/output distributor that allows the memory to be considered as a peripheral device, as the Junior does.

## merging BASIC programs

a utility program to merge two distinct basic programs and making use of utility software from the OS disk 2

The purpose of the program given here is to merge different BASIC programs or to place them one after the other. This alone makes it interesting and it is doubly so as it uses an interesting property of the Junior Computer's DOS and BASIC; namely that the memory can be used as an input/output device. This is a characteristic that the Junior shares with the majority of modern personal computers.

The distributor is a *software switch* which, when programmed accordingly, allows the workspace memory to be equated to the conventional peripheral devices (keyboard, VDU, parallel or serial printer, etc.) and also to the main memory, and this is the interesting point as far as we are concerned. In the OS65D DOS system the number of the memory as an input/output device is 5. For any system other than the JC's it will be necessary to refer to the user's manual to find the information needed to modify the program.

The distributor is managed by the DOS but it can be used directly in BASIC. The LIST 5 instruction, for example, causes the BASIC file to be transferred from the workspace (\$3ATE...), where it is in com-

part (tokenized) form, to \$8000 and from this address on it is found in integral ASCII format so that it can appear as easily on a VDU screen as on a printer. Address \$8000 is set by the DOS but can easily be changed by the user if he so desires.

To understand this operation it is important to know that the file is compacted in the interpreter's workspace. The BASIC instructions appear there in shortened form as indicators (tokens) or markers rather than as a series of ASCII codes corresponding to the letters making up the reserved words of the instructions. In the normal memory, on the other hand, we find the file in the familiar form after the LIST 5 instruction has been executed. The I/O distributor allows the memory to be used as an input device just as the keyboard is. The merging program makes abundant use of the possibilities this opens up.

### BASIC and merging

The program given here consists of a machine-code section (table 2) and a BASIC part, which is where we will now

```

2000 FOR X=1 TO 24:PRINT:NEXT
2010 PRINTTAB(10) "-----"
2020 PRINTTAB(10) "--FILE MERGE UTILITY--"
2030 PRINTTAB(10) "-----"
2040 PRINT:PRINT:PRINTTAB(10) "written by A. Nachtmann"
2050 PRINT:PRINTTAB(10) "feb. 19. 1984"
2060 PRINT:PRINT:PRINT
2070 PRINT "Be sure that both files to be linked have different line numbers."
2080 PRINT "If both files have some common line numbers boot up your system"
2090 PRINT "with the RESE utility to renumber the lines."
2100 PRINT:INPUT "In which drive are the files to be merged A/B/C/D?":D#
2110 D# = LEFT$(D#,1):D# = ASC(D#):IF D#ASC("A") OR D#ASC("D") THEN 2000
2120 PRINT:INPUT "enter first file name":F#
2130 INPUT "enter second file name":S#
2140 PRINT:INPUT "are you ready?":I#
2150 IF LEFT$(I#,1) <> "Y" THEN 2140
2160 REM --- RESET MEMORY INPUT POINTER
2170 POKE 9098,0:POKE 9099,128
2180 DISK!"SE A:DISK!"CA E400=12,7":DISK!"SE "+D#:DISK!"GO E401"
2190 A1=8X16^3+11:A2=8X16^3+2X16+4
2200 REM ---
2210 A#A1
2220 FOR X=1 TO LEN(F#)
2230 POKE A,ASC(MID$(F#,X,1)):A#A+1
2240 NEXT
2250 REM ---
2260 A#A2
2270 FOR X=1 TO LEN(S#)
2280 POKE A,ASC(MID$(S#,X,1)):A#A+1
2290 NEXT
2300 POKE 8993,16

```

Table 1. Unlike most of our recent software offerings this program is written in BASIC, or at least one part of it. This makes the job of adapting it for systems other than the Junior Computer that much easier.

```

HEXDUMP: E400,E4FF
      0 1 2 3 4 5 6 7 8 9 A B C D E F
E400: 50 4F 4B 45 38 39 39 33 2C 31 0D 0A 00 0D 0A 44 POKE8993,1.....D
E410: 49 53 4B 21 22 4C 4F 20 20 20 20 20 20 20 22 3A LIST"LO
E420: 4C 49 53 54 23 35 0D 0A 44 49 53 4B 21 22 4C 4F LIST#.DISK"LO
E430: 20 20 20 20 20 20 20 22 3A 4C 49 53 54 23 35 0D 45"LIST#.
E440: 0A 44 49 53 4B 21 22 47 4F 20 45 34 35 32 22 0D .DISK"GO E452".
E450: 0A 00 AE 91 23 AD 92 23 0E 46 E4 0D 47 E4 A2 00
E460: 0D 00 E4 F0 1B 0D FF FF EE 66 E4 08 03 EE 67 E4
E470: AD 66 E4 0D 91 23 AD 67 E4 8D 92 23 E8 D0 E1 60
E480: 60 A2 00 A9 80 0E 66 E4 8D 67 E4 A2 0D D0 D1 FF
E490: 00 FF 00 FF 00 FF 00 FF 00 FF 00 FF 00 FF 00 FF 00 FF
E4A0: 00 FF 00 FF 00 FF 00 FF 00 FF 00 FF 00 FF 00 FF 00 FF
E4B0: 00 FF 00 FF 00 FF 00 FF 00 FF 00 FF 00 FF 00 FF 00 FF
E4C0: 00 FF 00 FF 00 FF 00 FF 00 FF 00 FF 00 FF 00 FF 00 FF
E4D0: 00 FF 00 FF 00 FF 00 FF 00 FF 00 FF 00 FF 00 FF 00 FF
E4E0: 00 FF 00 FF 00 FF 00 FF 00 FF 00 FF 00 FF 00 FF 00 FF
E4F0: 00 FF 00 FF 00 FF 00 FF 00 FF 00 FF 00 FF 00 FF EE 21
E500:

```

Table 2. The second part of the MERGE utility is listed in this hexdump. This complements the BASIC program given in table 1.

```

HEXDUMP: 2200,2251
      0 1 2 3 4 5 6 7 8 9 A B C D E F
2200: A9 01 8D 5E 26 20 BC 26 A9 2A 05 FF 20 54 27 06
2210: FE 20 67 29 A0 BF 20 EC 22 F0 03 88 D0 F8 0C 00
2220: 23 20 AC 15 20 9E 0F 20 94 15 20 73 2D 0D 0A 2D
2230: 2D 20 44 49 53 4B 20 32 20 2D 0D 0A 0A 00 4C
2240: E6 2A 20 20 20 20 20 20 20 20 20 20 20 20 20
2250: 20 51

```

Table 3. Diskette 2 from the set of 5 supplied with the Ohio Scientific DOS contains a utility, RSEQ, that can be used to renumber lines in a file. The hexdump given here lists the modifications needed to adapt this for the Junior.

begin. As soon as it knows the unit where the files can be found (D\$) and their names (F\$ and S\$ are two arbitrary names that must be in the directory of the unit designated by D\$ — lines 2000... 2160) the processor initializes the pointer indicating the start address where the file transferred to memory can be found. It then loads a machine code program and a look-up table at \$E400 (from sector 7 of track 12; this is part of the space after the directory). The machine language program is started by the GO instruction at line 2180. This loads the series of instructions found in the right side of table 2 in direct mode (i.e. without line numbers) into the area from \$8000 on. From line 2190 to line 2290 the BASIC program places the names of the files that are to be merged (F\$ and S\$) in direct mode after the two LO instructions that have just been loaded. The instruction at line 2300 programs the distributor to make the memory the input device. The BASIC editor then receives the sequence of instructions starting at \$8000 as if they were input one-by-one via the keyboard and it then executes them one after the other. What this means is that it loads file F\$, transfers it to \$8000 (LIST 5), and then loads file S\$ and transfers it, in turn, to the space after F\$. It then executes the DISK! "GO E452" instruction which is the last it receives in direct mode from the memory as an input device.

The machine-code program at \$E452 places a POKE 8993,1 instruction in direct mode after the two files loaded at address \$8000 and as this instruction has no line number it will be executed as soon as the interpreter meets it. The purpose of this last command is to reestablish the input

distributor in its original form where the keyboard is the input device. Now the BASIC editor loads files F\$ and S\$ into its workspace to form a single new file which it compacts and lists as it goes along.

When it arrives at the last numbered line in the second file it finds the POKE 8993,1 instruction which it executes in direct mode thus making the keyboard again the active input device.

If a LIST instruction is now given the display on the screen will show that the workspace does, in fact, contain files F\$ and S\$.

## RSEQ

In order to be able to effectively merge existing files it is essential to be able to easily manipulate the numbering of the lines in both files and then later of the single file resulting from the merger. On disk 2 of the 5 supplied with the Ohio Scientific DOS is a utility program called RSEQ that could be used to perform this task. Until now none of the myriad articles on the various aspects of the Junior Computer have dealt with adapting disk 2 for the Junior. The hexdump given in table 3 does just that, enabling JC users to easily change the line numbering of BASIC files, especially those that are to be merged. The adaptation procedure is quite simple. First copy the master diskette (this is always advisable as a safeguard) and then load track 0 of disk 2 by means of the TRACK 0 R/W UTILITY (RA200) at address \$A200 (or elsewhere). The contents of this track must then be changed according to the hexdump in table 3 and the modified first page of track 0 is then reloaded to the diskette (WA200/2200,8). And that's all, folks!

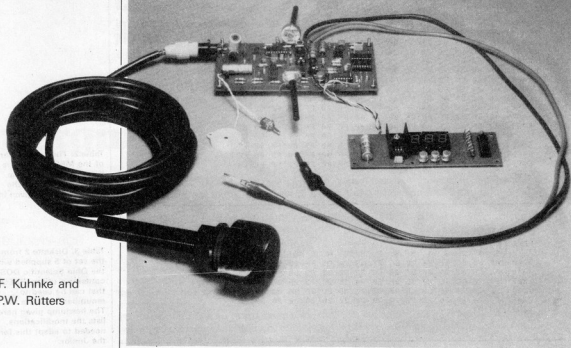

F. Kuhnke and  
P.W. Rütters

# echo sounder

Running a yacht aground does not necessarily mean its destruction, or even that there is any damage, but no skipper is happy with it. At best, it means a lot of effort to get the craft afloat again; at worst, well that does not bear thinking about . . . It can safely be said that many such mishaps could have been prevented by the judicious use of some sort of sounding apparatus!

## sonar for yachts

sonar is an acronym of  
sound navigation ranging

MMV = monostable  
multivibrator  
FF = flip-flop (bistable  
multivibrator)

Figure 2. The block schematic is self-evident: the neon lamp has been replaced by a digital display. Underwater sound projector and hydrophone are housed in a common case, while the transmitter and receiver are contained in one IC. Furthermore, a 'shallow depth' alarm has been provided.

In the past, sounding, that is, measuring the depth of the sea bed, was carried out by a weighted line, the sounding-line. Nowadays, these are found almost exclusively on board yachts only. They consist of a ball of lead (the weight) and a line that has been marked suitably at regular intervals, so that when the lead touches the sea bed the depth can be read off the line. The big disadvantage of such a sounding-line is that it can only be used at low speeds and at shallow depths. The echo sounder does not suffer from these disadvantages and, moreover, its indicator may be mounted in the wheelhouse near the other navigational aids. An echo sounder is a sonar system that measures the time interval between the transmission of a burst of ultrasonic energy and reception of the consequent reflected waves. In this, a specially designed electro-acoustic transducer is used of which the transmitter is called an underwater sound projector, while the

return echo is detected with a hydrophone.

The usual configuration of an echo sounder is shown in figure 1. The sound projector transmits a pulse in the frequency range 150 . . . 200 kHz. This pulse is reflected by the sea bed and detected by the hydrophone. The hydrophone converts the echo into an electrical signal which is used to fire a small neon tube which is motor-driven at uniform speed along a concentric, calibrated disc. The neon lamp thus fires at a scale division corresponding to the depth sounded. As the pulse is transmitted at exactly the moment the neon lamp passes through zero, the depth can be read off directly. Experienced skippers are also able to deduce the type of sea bed. For instance, sandy ground causes a narrow flash of light, stony ground a wider one with a frayed top, and soft ground an even wider one with a frayed bottom.

The present design has a digital read-out

which, unfortunately, does not allow an indication as to the type of sea bed, but it has the advantage of being somewhat smaller, and the depth can be read more accurately. It is also easier to build yourself as the block schematic in figure 2 shows. An important simplification is also that the sound projector and hydrophone are contained in one and the same housing which is connected to one IC(9), type LM 1812 manufactured by National Semiconductor.

## The circuit

The ultrasonic pulse travels a distance equal to twice the depth of the sea bed. As the average speed of sound in water is 1500 m/s (at 20°C and salinity of 2 per cent), the time taken to travel to and from a depth of, say, 7.5 m is 10 ms. If therefore the clock frequency for the counter in IC1 is 750 Hz and pulses are registered for 10 ms, it has effectively 'sounded' a depth of 7.5 m. However, as the counter can only cope with complete pulses, a depth of 7 m would be indicated. To provide a more accurate indication of depth, the clock frequency is increased to 7500 Hz and this allows depths to be read in decimetre steps.

The counter, backing store, and 7-segment decoder are contained in IC1. The counter receives a stop pulse from IC9 when the echo is detected. The counter position is then passed to the decoder by the backing store and indicated on a three-digit display.

A reset pulse from IC5 starts a new count cycle. As IC5 generates a pulse every 200 ms, 1500 pulses can be counted. This means that the circuit is usable for depths up to 1500 decimetres = 150 m. The reset signal serves two further functions: it starts the transmit pulse, and it sets off the alarm via MMV4 and FF2. This means that the output of FF2 generates a 'shallow depth' alarm if the output level of the MMV is logic high at the moment the echo is detected. The alarm threshold can be set between 1 m and 10 m with P1.

The various functional blocks of figure 2 can be found back readily in figure 3. Monostable MMV3 ensures that the display is switched off when no echo has been detected for some time: this time can be set with P2. When no echoes are received, LED D2 also remains extinguished. The display remains switched on until MMV2 changes state. When an echo is detected, D2 starts to flash immediately.

As IC9 is the heart of the circuit, it's worthwhile having a closer look at it. The individual stages contained in the IC are shown in figure 4, together with the necessary peripheral elements. If IC5 provides a 0.5 s pulse to pin 8 of IC9 every 200 ms, the on-chip modulator is actuated and generates the pulse for the sound projector, in this case at a frequency of 200 kHz. The modulator and 2nd h.f. amplifier have tuned circuit L1/C14 in common. During transmission, this circuit

1

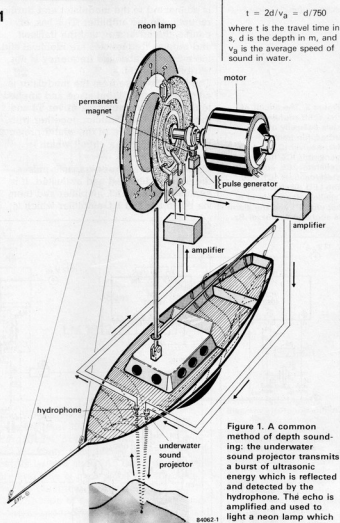
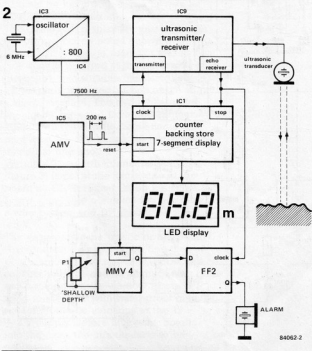

Figure 1. A common method of depth sounding: the underwater sound projector transmits a burst of ultrasonic energy which is reflected and detected by the hydrophone. The echo is amplified and used to light a neon lamp which is motor-driven around a depth-calibrated disc.

2



is connected to the modulator and during reception to the amplifier. This has, of course, the advantage that the transmit and receive frequencies are identical and, moreover, the absolute frequency is not terribly important.

The 200 kHz pulse from the modulator is amplified in the output stage and applied to the sound projector via driver T8 and inductor L2. This inductor, together with the self-capacitance of the sound projector and C22, forms a circuit which is tuned to 200 kHz.

In the interval between transmit pulses, the echo is detected and evaluated. It is applied to the 1st h.f. amplifier and then, via P4, to the 2nd h.f. amplifier which is

now connected to L1/C14. The potentiometer enables setting the sensitivity of the echo sounder. The output of the selective amplifier is applied to a threshold detector which only reacts to signals which lie above a certain level. Noise pulses on the signal are suppressed by a combination of pulse recurrence detector and integrator. If the pulse train is interrupted, the pulse recurrence detector evaluates the received echo as spurious and causes integrator capacitor C15 to discharge. If the received pulses are too short (as, for instance, noise pulses), C15 does not charge fully and the pulses are rejected as spurious. If the detector is fed with a true echo, the

Figure 3. The circuit of the echo sounder consists basically of the ultrasonic transmitter/receiver IC19, clock generator IC3/IC4, pulse generator IC5, counter/store/decoder IC1, and the LED display. The 'shallow depth' alarm is set with P1 and the alarm is sounded by buzzer Bz.

3

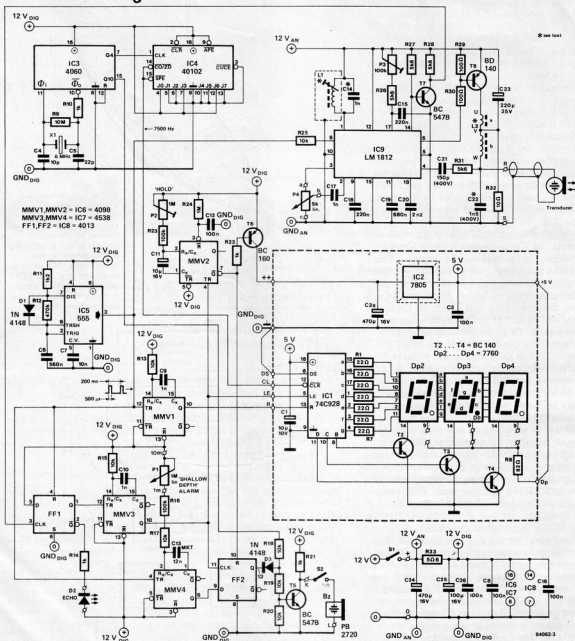

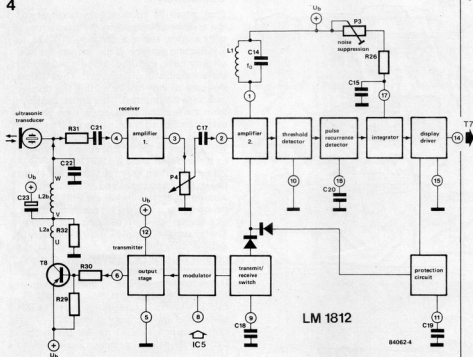

display driver is switched on. A protection circuit briefly switches the receiver off if the display driver has been on too long. This is effected by the charging of capacitor C19 from the signal at the driver stage; when C19 is charged, an on-chip transistor is switched on. Capacitor C9 ensures that the gain of the 2nd h.f. amplifier is low immediately after a pulse has been transmitted to prevent any ringing of the transducer being evaluated as an echo. This causes the minimum depth that can be sounded to be around 2 m. If this is not acceptable, the value of C9 may be reduced. Note that the sensitivity in that case must also be decreased.

### Construction and assembly

The most important aspect is, of course, the fitting of the transducer: some possibilities are shown in figure 5. It is essential that it is fitted perpendicular to a line drawn through the length and to one drawn through the width of the vessel. It may be necessary to mount the transducer onto a suitably shaped adapter as shown in figure 5c. If the hull is of fibre-glass, the whole assembly may be fitted in-board. The cable from the transducer to the electronic part of the echo sounder must not be tied together with other cables, as this might give rise to noise pulses which would upset the proper operation. An important point here is NOT to shorten the cable provided with the transducer! If you already have an echo sounder, there's no need to buy another transducer, as the one you are using already is almost certainly suitable for the present circuit.

The VDO Echo Sounder Modis 120 (operating on 200 kHz), or Spaceage, Euromarine, or Seafarer (all operating on 150 kHz) have transducers which can hardly be told apart. All these transducers are available at most ship's chandlers or marine electrical suppliers.

Construction of the electronic part of the echo sounder on the printed-circuit board shown in figure 6 is child's play compared with the fitting of the transducer. Inductor L2 must be hand-wound, but L1 may be bought ready made.

The three-digit display is constructed on the printed-circuit board shown in figure 7. The voltage regulator and its heat sink should be fitted at the track side of the board onto suitable (insulated) spacers or, properly insulated, at one of the side-walls of the case. The two pc boards should be screened from one another by an earthed metal plate. Same-name terminals on the two boards should be connected to one another.

**Warning!** The earth connection of CL (figure 7) is not at the same side of the board as CL. Terminal DS on the same board should be connected to earth with a wire bridge, and DP should be wired to +5 V.

The case should be plastic or metal and — important — splash-proof. Spindles of potentiometers and switches, LEDs, and sockets, must be sealed during fitting. The red perspex display window must be fixed to the case with water-proof glue. Do not forget the connections to the 12 V  $\pm$  2 V supply. Before fitting the boards into the case, the circuits have to be calibrated.

Figure 4. The block diagram of the ultrasonic transmitter/receiver IC3 is shown here to give a better idea of the operation of the circuit. The receiver sensitivity is set with P4, while P3 enables a good measure of noise suppression. Tuned circuit L1/C14 is common to the transmitter and receiver. Fine tuning of the circuit is possible by means of L1.

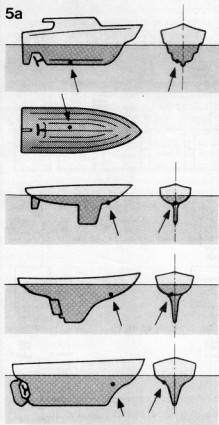
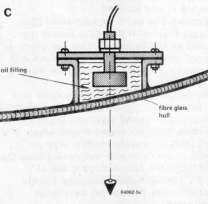
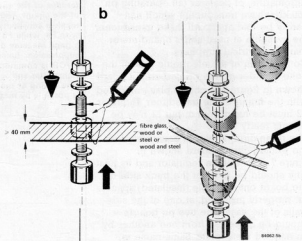

Figure 5. A number of useful tips on positioning the transducer (figure 5a). Figure 5b shows how the transducer may be flush-fitted or otherwise. Figure 5c shows how the transducer may be mounted in-board when the vessel has a fibreglass hull.



Photograph. The echo sounder must be calibrated such that the received signal (second pulse) on pin 1 of IC9 is maximum for all true echoes.

scale division  
vertical:  
upper pulse (IC5 pin 3)  
5 V/division (d.c.)  
lower pulses (IC9 pin 1)  
1 V/division (a.c.)  
horizontal:  
1 ms/division

### Calibration

First, adjust P4 for maximum sensitivity of the receiver. Next, place the transducer at right angles, and at a distance of 0.5 m, to a reflecting surface. If the transducer has already been installed, place a reflecting surface similarly in front of it. Then adjust the core of inductor L1 so that the display indicates 2.3 (metres). This figure results from the fact that in identical time intervals sound in air travels only 0.217 as far as it would in water. Since the simulated water depth is 0.5 m, the circuit behaves as if the depth were  $0.5/0.217 = 2.3$  metres. Then vary the distance between the transducer and the reflecting surface: in air this lies approximately between 0.5 and 1...1.5 m, corresponding to a displayed depth of 2.3 to 4.6...6.8 m. The change in distance must be clearly indicated by the display; if it does not, the core of L1 must be adjusted until the real maximum sensitivity has been found. If you have an oscilloscope available, calibration is somewhat easier. But BE CAREFUL with connecting a probe to IC9 because if any two pins of this IC are short-circuited, it gives up the ghost. Let our (unfortunate) experience be a warning to you!

Connect the probe of the oscilloscope to pin 1 of IC9 and trigger the oscilloscope with the signal at pin 3 of IC5. Then adjust the core of L1 for maximum amplitude of the echo which is visible a few milliseconds after the transmit pulse (see photograph). The current consumption of the echo sounder with the display on is about 200 mA or an average of 40 mA at 12 V.

### Some final points

Inductor L2 must be home-made on a suitable pot core of about 18 mm diameter and 11 mm height. The inductance of the secondary winding, L2b, should be such that the resonant frequency of the circuit formed by it, the transducer self-capacitance, and C22 is exactly the same as that of the transducer. It may be calculated from  $f = 1/2\pi\sqrt{LC}$ , where  $f$  is the resonant frequency in Hz,  $L$  is the inductance in H and  $C$  is the total capacity in F.

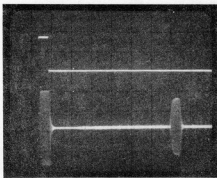



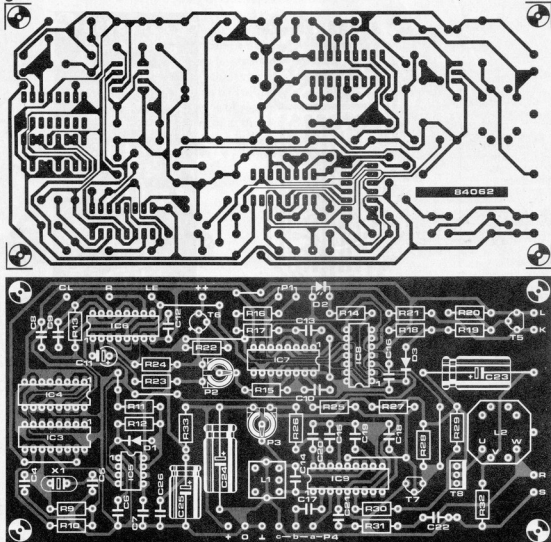

## Parts list

## Resistors:

R9 = 10 M  
 R10, R14, R21, R22 = 1 k  
 R11 = 1k2  
 R12 = 470 k  
 R13, R15, R17, ... R20,  
 R25 = 10 k  
 R16, R23 = 100 k  
 R24 = 1 M  
 R26, R27, R28, R31 = 5k6  
 R29, R30 = 100  $\Omega$   
 R32 = 10  $\Omega$   
 R33 = 526  
 P1 = potentiometer, 1 M,  
 linear  
 P2 = preset, 1 M  
 P3 = preset, 100 k  
 P4 = potentiometer, 5 k,  
 linear

## Capacitors:

C4 = 10 p  
 C5 = 22 p  
 C6 = 560 p  
 C7 = 10 n  
 C8, C12, C16, C26 = 100 n  
 C9, C10, C14, C17 = 1 n (see  
 text for C14)

C11 = 10  $\mu$ /16 V for  
 vertical mounting on pc  
 board

C13 = 12 n MKT  
 C15, C18 = 220 n  
 C19 = 680 n  
 C20 = 2n2  
 C21 = 150 p (400 V)  
 C22 = 1n5 (400 V) (see  
 text)  
 C23 = 220  $\mu$ /25 V  
 C24 = 470  $\mu$ /16 V  
 C25 = 100  $\mu$ /16 V

## Semiconductors:

D1, D3 = 1N4148  
 D2 = LED red  
 T5, T7 = BC 547B  
 T6 = BC 160  
 T8 = BD 140  
 IC3 = 4060  
 IC4 = 40102  
 IC5 = 555  
 IC6 = 4098 (or 4538 — see  
 text)  
 IC7 = 4538  
 IC8 = 4013  
 IC9 = LM 1812 (National  
 Semiconductor)

## Inductors:

L1 = 630  $\mu$ H = YAN 60033  
 (Toko) (available from  
 Ambit)  
 L2 = see text (a suitable  
 pot core, RM 10, which  
 however does not quite fit  
 the pc board, is available  
 from Ambit)

## Miscellaneous:

S1, S2 = SPST toggle  
 X1 = quartz crystal, 6 MHz  
 Transducer, 150 kHz or  
 200 kHz (available from  
 most ship's chandlers or  
 marine electrical suppliers  
 as spare for Seafarer,  
 Euromarine, Spaceage,  
 VDO, and other echo  
 sounders)  
 Coaxial socket, panel  
 mounting (to receive the  
 transducer cable)  
 Splash-proof case  
 Socket, panel mounting, for  
 12 V supply cable  
 Piezo buzzer PB 2720  
 PC board 84062

Figure 6. Layout and track side of the printed-circuit board of the echo sounder. The board should be housed in a splash-proof case.

## Parts list

## Resistors:

R1 . . . R7 = 22  $\Omega$   
 RB = 82  $\Omega$

## Capacitors:

C1 = 10  $\mu$ /10 V tantalum  
 C2a = 470  $\mu$ /16 V  
 C3 = 100 n

## Semiconductors:

DP2 . . . DP4 = 7760(D)  
 T2 . . . T4 = BC 140  
 IC1 = 74C928  
 IC2 = 7805

## Miscellaneous:

Heat sink for IC2  
 (about 5°C/W)  
 PC board 81105-1

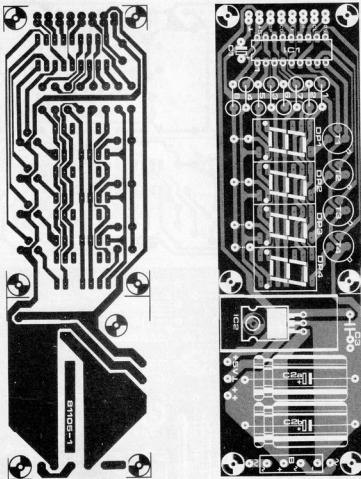

Figure 7. The component layout and track side of the printed-circuit board for the display. The voltage regulator, complete with its heat sink, may be mounted onto one of the side-walls of the case (on insulating spacers if a metal case is used).

By transposition,

$$L = 1/4\pi^2 f C$$

which with  $f = 200$  kHz,  $C = 3n2$  gives a value for  $L2b = 198 \mu H$

The corresponding number of turns, N, is calculated from

$$N = \sqrt{L2b/Ls}$$

where  $Ls$  is the specific inductance of the pot core. If, for instance,  $Ls = 250$  nH, the number of turns works out at 28.

If the turns ratio, n, is chosen at 1:9,  $L2a$  must be 3 turns.

When a pot core with different specific inductance is used, the above calculation for N must, of course, be redone; the turns ratio may be kept at 1:9. Equally, when a different transducer is used, the inductance of  $L2$  must be recalculated.

Furthermore, if the frequency is not 200 kHz, capacitor C14 should be recalculated from  $C14 = 1/4\pi^2 f L1$ , where f is the new frequency and  $L1 = 630 \mu H$ .

The depth at which the 'shallow depth' alarm is actuated may be set with the aid of the following formula

$$\text{depth (m)} = 9 \times 10^{-4} (P1 + R16 + R17)$$

where P1, R16, and R17 are in ohms.

Where the transducer is not fitted at the deepest part of the vessel, measure the distance, Dk, between the underside of the transducer and the lowest part of the keel. Replace the 4098 in the IC6 position by a 4538, change C9 to 12 n, and connect a resistor Rk in series with R13. The value of Rk is calculated from:

$$Dk = 9 \times 10^{-4} (Rk + 10^4)$$

where Dk is in metres and Rk in ohms. Therefore,  $Rk = 10^4 Dk / 9 - 10^4$

If, for instance,  $Dk = 1.5$  m, the value of  $Rk = 157$  k. The display will then, of course, indicate the depth between the deepest point of the keel and the sea bed, not that between the transducer and the sea bed.

Warning! When setting and calibrating P1, Dk must, of course, be borne in mind.  $\blacksquare$

The display of this versatile audio peak meter is formed by a row of LEDs and features a 'peak hold' facility that can be used while the normal signal levels are monitored. The meter includes an input buffer stage that can be switched to enable the monitoring of signals at loud-speaker level or at line output level. An optional variable-frequency band-pass filter is also included.

A.B. Hill

# audio peak meter . . .

. . . with peak hold facility

As the input sensitivity can be matched to either line level or power amplifier output level, the audio peak meter may be used with virtually any sound system. Line level inputs may lie between 150 mV and 5 V while the power handling capability extends up to 250 W. Other characteristics are shown in the box at the beginning of this article. The display characteristics may be tailored to provide a peak response or a simulated VU response.

Like many circuits of this nature, the present one can be broken down into various stages as shown by the block diagram of figure 1. The first stage is the input buffer which includes gain adjustment for the input level matching. The variable band-pass filter is an optional stage that may be useful in particular applications. The next stage consists of a full-wave rectifier and provides overall gain adjustment for the following peak and buffer stage. Finally there is the display decode section. The display is formed by a row of LEDs with either 'dot' or 'bar' mode of operation.

## Specification

### Input shaping circuit

- output, maximum: 11 V, 20 mA (d.c.)  
rated: 10 V (d.c.)
- input, loudspeaker: 10 . . . 250 W peak into 8 ohms for rated output  
line: 150 mV . . . 5 V (d.c.) for rated output  
calibration: 950 mV (corresponding to 10 W into 8 ohms)
- frequency response: bandwidth at  $-3$  dB of rated output better than 100 kHz  
cut-off frequency 70 Hz
- low-pass filter: slope  $-6$  dB/octave ( $-20$  dB/decade)
- band-pass filter: gain at centre frequency 0 dB  
centre frequencies 200 Hz, 500 Hz, 1250 Hz, 3 kHz, 8 kHz  
 $-3$  dB points 125 Hz, 320 Hz, 800 Hz, 2 kHz, 5 kHz, 12.5 kHz  
slope  $-12$  dB/octave ( $-40$  dB/decade)

### Display driving circuit

- LED switching thresholds (dB)  $-40, -20, -10, -6, -3, 0, +2, +4, +6, +8, +10$
- typical corresponding peak power levels (W)  $10^{-3}, 10^{-1}, 1, 2, 5, 10, 15, 25, 40, 60, 100$
- input voltage for  $+10$  dB switching threshold: 10 V (d.c.)

## The circuit diagram

### The input shaping circuit

The various inputs to be monitored are selected by switch S1a in the input buffer stage of the circuit diagram shown in figure 2a. Position 1 of S1a connects the input to earth and this is therefore the 'off' position. Position 2 selects a calibration signal input, of which more later. The loudspeaker power level input is selected by position 3 while various line outputs are selected by positions 4, 5, and 6. This method allows the meter to be used readily for monitoring in widely differing situations. The gain of the input amplifier is adjusted automatically by switch S1b. The addition of suitable resistors to positions 4, 5, and 6 enables the peak meter to cater for a wide range of input levels.

The next stage consists of a variable-frequency band-pass filter which enables selective metering of the signals as in a real-time analyser. The stage has unity gain and may be omitted as required by simply connecting the output of input amplifier A1

Figure 1. This diagram shows typical constituent stages in an audio peak meter.

1

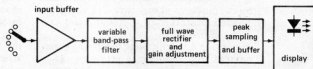

84065-1

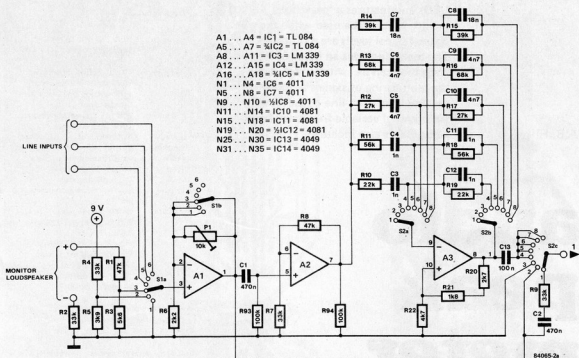

Figure 2a. The input signal shaping circuit complete with the optional band-pass filter based on A2.

directly to the non-inverting input of opamp A4 with switch S2 in position 2. The other positions of S2 select the required filter response.

Position 1 provides a high-pass response and constitutes a rumble filter. Position 3 connects the non-inverting input of A4 to earth, which switches off the opamp. The remaining positions, 4 . . . 8, select various frequency bands that are provided by a Wien bridge band-pass filter constructed around opamp A3.

The output of the variable band-pass filter is passed to a precision full-wave rectifier consisting of A4 and A5. Preset P2 in the feedback loop of opamp A4 provides gain adjustment applicable to all input levels: it is adjusted at the appropriate calibration input level. Operation of the rectifier is as follows: opamp A4 increases the magnitude of both positive and negative signals by the forward voltage drop across diodes D1 and D2. The resultant signal is rectified by A5 and the consequent drop across D3 and D4 cancels that introduced by D1 and D2. The rectifier is followed by a peak charging stage, opamp A6. The peak sampling response is selected by switch S3: it is effected by the discharge of capacitor C15 via switch-selected resistors R28 . . . R30 in series with R31 and/or R32.

In position 4 the discharge resistor has been omitted: this results in a very slow discharge rate which is only due to the input currents of opamps A4 or A5 and the reverse (leakage) current of diode D6. In position 5, the charge and discharge rates

(via R32 and R33 respectively) are about equal and produce a simulated VU response. The final stage of the input shaping circuit consists of an output buffer, opamp A7, which adjusts the gain in the 'peak' and 'VU' positions.

#### The display drive unit

The display (see figure 2c) consists of a row of LEDs: the switching threshold for each LED is determined by resistors R38 . . . R61. The reference voltages,  $U_r$ , fixed by these resistors are applied to one of the inputs of comparators A8 . . . A18, while the input signal from A7 is fed to the other inputs. Note that the polarity of the comparator inputs depends on the input signal and on  $U_r$ . When the level of the input signal exceeds that of one of the thresholds, the relevant comparator switches off and its output is pulled up to +9 V.

Switch S4 selects a moving dot or bar display. In the bar mode, the outputs of gates N1 . . . N10 are held high. When any comparator switches off, the corresponding AND gate, N11 . . . N20, receives a second high input and thus provides a high output. This results in the LED in that particular channel being switched on.

In the dot mode, the outputs of gates N1 . . . N10 are dependent on the state of the output of the next higher comparator. When a given comparator output is high while the next higher output is low, both inputs of the relevant AND gate, N11 . . . N20, are high so that the appropriate LED lights. However, when a given comparator output is

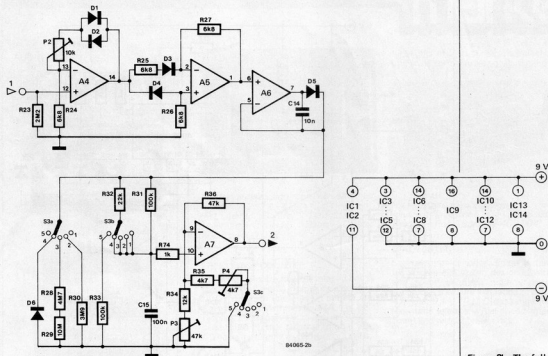

Figure 2b. The full-wave rectifier, gain adjustment, and peak charging stages.

high while the one above is also high, both the NAND and AND gate outputs will be low, and the LED will remain off. In the dot mode, therefore, only the topmost comparator with a high output causes an LED to be switched on.

A further facility of the display is that of 'peak sampling', which means that the highest LED that lights will remain on until the 'peak display' function is disabled. The four R-S latches of IC9 are controlled by switches S5 and S6 and provide the peak sampling. The latches are enabled when both switches are closed and reset by the brief opening of S6. Each latch reset is also connected to the outputs of all higher latches via diodes D7 ... D12. The latches are set whenever their LED is switched on by the display logic. However, the diodes effectively provide an OR reset to the latches with the result that only the uppermost latch to be set will hold an LED on. The operation of the normal dot or bar mode is independent of the peak display and a latched peak LED will therefore not hold lower LEDs off. This means that a peak level may be held while the normal dot or bar mode continues to function.

### Calibration

It will be patently obvious that any level indicating mechanism is only as good as its calibration, a fact any pilot who survived a duff altimeter will tell you!

Initially, the calibration input level should be set to suit the power levels to be monitored: the one used here is 950 mV (d.c.) which corresponds to 10 W (peak) into an 8-ohm load. All preset potentiometers should be set to the middle of their travel,

and switches S1 ... S3 set to the following positions:

S1 - position 2 (calibration input)

S2 - position 2 (filter bypass)

S3 - position 2 (peak response)

Adjust P2 to the correct output from opamp A7. It may be necessary to adjust P3 if the reading cannot be achieved with P2 alone. The output may be monitored on a DVM (digital voltmeter) or an LED display. Next, move S3 to position 5 (VU mode) and adjust P4 for the appropriate reading. The loudspeaker input can now be calibrated by setting S1 to position 3 and adjusting P2. Calibration of the line inputs is more subjective. If a line input is to be used with a tape recorder, the recorder metering may be used for comparison, particularly if it responds to peaks. In that case, a steady audio tone from a test record or oscillator is required, but inter-station hiss replayed from tape is an alternative. It should be noted that the line output should be used when the recording level of a tape recorder is monitored.

Where tape recorder metering is not used, the line level may be calibrated to a direct voltage derived from equipment specifications or by calculation. It may then be necessary to multiply r.m.s. values by 1.414 ( $\sqrt{2}$ ) to get peak values. A line voltage often used for 0 dB (the Dolby level) is 500 mV peak. Whatever method is used, P1 should be adjusted to obtain the appropriate level at the output of opamp A7. Switch S1 must be set to one of the line inputs (4...6) while switches S2 and S3 should remain in position 2 (filter bypass and peak response respectively).

The 'normal' level used in audio engineering is 1 mW into 600  $\Omega$  (= 775 mV across 600  $\Omega$ ) and is conventionally designated 0 dBm.

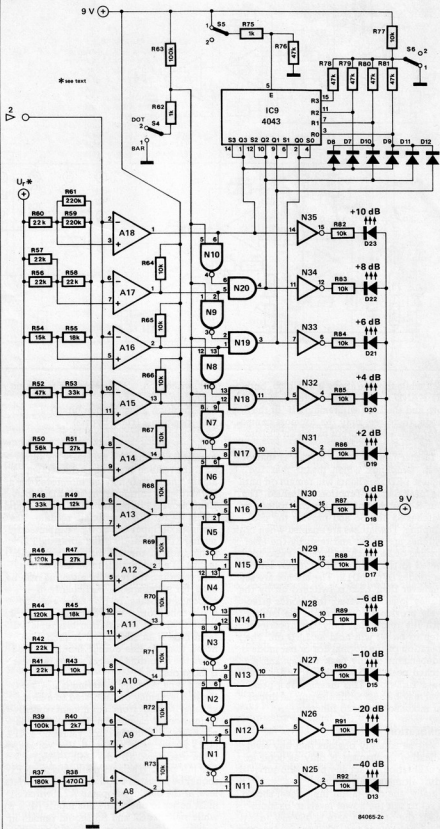

Figure 2c. The display drive circuit is not nearly as complicated to build as it looks.

## AUDIO CASSETTES

La Safari Industries are manufacturing "Safari" cosmic memory audio cassettes in three ranges—CM60, CM90 and HC10.



For more information contact :  
La Safari Industries, 11, Tribhuvan Road,  
BOMBAY-400 004.

## POWER SUPPLY

Spectron offers "Uninterruptible power systems" in the range of single phase output upto 5KVA and 3-phase outputs upto 10 KVA. Systems with single phase or 3-phase inputs are available. Automatic, solid state static switches ensure instantaneous switching over.

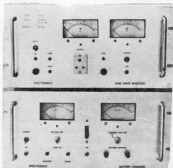

For more details, write to :  
Spectron sales and service private  
limited, 63, Bharatkunj no.2, Erandvane,  
Pune-411 038.

## JUMPER WIRES

The PVC insulated jumpers are 22 swg, solid, tinned copper wires, pre-cut and turned-90 degrees at both ends to allow easy insertion on circuit boards. These jumpers make the job of cutting, stripping and bending wires for connecting components redundant, either in solderless or soldered circuit applications.

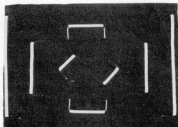

Further information can be obtained from :  
Instrument Control Devices, 14,  
Manorama Niwas, Datar Colony,  
Bombay-400 078.

## FREQUENCY COUNTER

Vasavi Electronics have developed one of the smallest digital frequency counters, VDC 18, which operates on battery and mains as well. With seven digit, 0.5" LED display its frequency range is 30MHz sensitivity, 10 m.v. Another, model VDC 19 has a frequency range upto 500MHz.



For details contact :  
Vasavi Electronics, 162, Vasavi Nagar,  
Secunderabad-500 003.

## P-CLIPS

Novoflex have introduced non-corrosive and non-conductive P-clips for fixing cables, pipes and components in domestic and industrial appliances. The adjustable type AP clips over cable or cable loom ranging from 14 mm to 30 mm. Type BP are adjustable through four fixing holes. The P series non-adjustable clips are available in cable loom diameter range upto 12 mm.

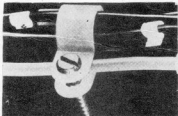

For further details : write to :  
Novoflex cable care systems, P. Box no.  
9159, Calcutta-700 016.

## INVERTER

This is a transistorised unit, operating on a 12V car battery. It is suitable for operating one 40W tubelight of 4' or two 20W

tubelights of 2' in series. This electronic unit gives normal tubelight illumination.

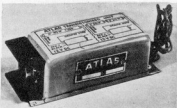

For more information, contact :  
Advance Industries, Tirwala Building,  
Tribhuvan Road, Bombay-400 004.

## DIAL TESTER

Sbaj electronics offer digital insulation tester-cum-dial tester, designed with IC and seven segment read-out display, which can measure insulation of cable in 4 M Ohms and 10 M Ohms range. It also measures telephone dial speed, impulse count and weight break ratio.



More details can be had from :  
Sbaj Electronics, 19, Mother Gift  
Building, Grant Road, Bombay 400 017.

## DIN TRANSFORMER

Din type current transformers, conforming to DIN 42600, housed in ABS plastic casing, for metering applications are available with Mecro instruments. The transformers are made in a standard range from 50/5A with a burden of 1.5 A upto 600/5A with a burden of 15 KVA.

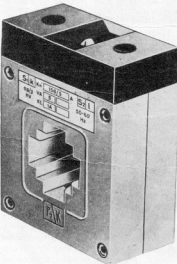

For further details contact :  
Mecro Instruments private limited, 310,  
Bharat Industrial Estate, T.J. Road,  
Sewree, Bombay-400 015.

## SOLAR CELL TESTER

An instrument to test solar cells and solar panels, Solarest-9001, produced by Anika can be used for testing photovoltaic solar cells and solar panels at constant voltage or constant current in forward and reverse bias. It can plot IV and PV curves and compute open circuit voltage and short circuit current.

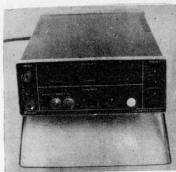

Further details are available with  
Anika Instruments Private Ltd.,  
12/4, Milestone,  
Mathura Road,  
Faridabad 121 003.

## TEMPERATURE INDICATOR

A portable digital temperature indicator, ESD-100, has been developed by Electronics systems and devices, manufacturers of electronic process control instruments.

Housed in a small, plastic moulded cabinet with LCD, ESD-100 is designed to measure in the range 0 to 1200 degree C. The source of power supply is a 9V battery. Mechanical vibrations and holding position do not affect the accuracy of the reading.

The company has also developed a digital temperature indicator/controller, called ESD-90/ESD-92.



More details can be obtained from  
Electronics Systems and Devices,  
38-39/7, Hadapsar Industrial Estate,  
Pune 411 013.

## GAUSS METER

For measuring DC magnetic flux density, Industrial Research Associates have developed a Gauss. This gauss meter is based on the hall effect. For measuring flux in small gaps thin probes are supplied. The instrument may be used for routine checking of permanent used magnets, electro-magnets, solenoids, relays, radar and microwave equipment, DC machines, loudspeakers and magnetic crack detection.



For further information contact  
Industrial Research Associates,  
302, Acharya Commercial Centre,  
Near Basant Talkies, Chembur,  
Bombay 400 074.

## LCD - DPM

Lascar Electronics of Wiltshire have introduced a low power LCD DPM with digital hold of displayed reading. Consuming just 1 mA from a 7 to 15V supply, the DPM 10 features auto-polarity auto-zero, 200mV f.s.d., low battery indication, 12.5 mm digit height and programmable decimal points.



Trade enquiries may be addressed to  
Electronics India Co.,  
3749, Hill Road,  
Ambala Cantonment 133 001.

## EPOXY-COATED RESISTORS

High voltage, high values, epoxy-coated resistors are made available by the Bangalore-based Al Ameen commercial and industrial company to withstand pulse voltages of upto 1500 volts. The resistors with close tolerances find application in black and white and colour television sets.

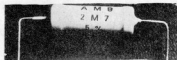

Contact:  
Al-Ameen commercial and industrial  
company limited, 23/1, Second floor,  
Crescent Road, Bangalore-560 001.

## ECHO REVERB UNIT

Selectronics (Gujarat) private limited have introduced a solid state device, "Echo Reverb Unit" to produce echo, reverbation and a host of other interesting effects. The unit can be easily added to any existing audio or music system and it can also be used for recording echo.



For more details, write to:  
Selectronics (Gujarat) private limited, 5,  
Ruxmani Park, Kankaria,  
Ahmedabad-380 022.

## COMPONENT BIN

Time engineers have devised Component bin IS-21 for storing and easy handling of electronic and light engineering components on the assembly table. A 300 degree swing of the trays facilitates two operators to work simultaneously.

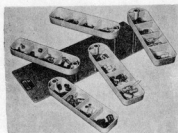

For more details, write to:  
Time Engineers, P.Box. 308, M.I.D.C.  
Railway Station, Satara Village Road,  
Aurangabad-431 005.

## PERTEC'S PRODUCTS

Pertec peripherals corporation, USA, markets its products on computer peripherals in India through Sujata sales and electronic limited. This firm will also be responsible for maintenance of all Pertec equipment sold in India. Pertec's popular product range includes vacuum column tape drives, tension arm tape drives, the streaming tape drives and Winchester cartridge disk drives. In addition, "Sujata" markets printers, disk drives, floppy disk drives and terminals, are widely used in the Indian computer industry. Pertec's "Vindicator" series 1/2" streamer tape drives.

To support 10 1/2" tape spools, with a speed of 100 IPS, will also be marketed by Sujata.

For more information contact:  
Sujata Sales & Electronics Ltd. 112, Bajaj  
Bhavan, Nariman Point,  
Bombay-400 021.



## Miniature solid state relays

Norbain Electro-Optics Ltd. has launched a completely new range of switch-DIP miniature solid state relays. Manufactured by MSI, the device range consists of three d.c. and seven a.c. types covering a wide range of voltage and current options with opto or transformer isolation and synchronous or zero voltage switching. Housed in standard 14 and 16 pin sealed ceramic DIL packages to improve herme-

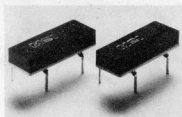

ticity and aid the conduction of heat energy, the devices employ thick-film hybrid techniques to achieve a high power handling capability in a small package.

Heading the new range is the E24E-2H 16 pin package which has a 1A RMS rating and input to output isolation of 400 V RMS. The device switches at the zero voltage point of the a.c. waveform, requires an input signal of 8 mA at 5 V and has a peak voltage rating on the output switch of 600 V. Anti-parallel SCRs in the power switch ensures enhanced DV/DT surge current and thermal characteristics. Other devices in the range include the E40-1 capable of switchings a.c. and d.c. currents to  $\pm 80$  mA at  $\pm 60$  V, the E41-2H rated at 1 A RMS a.c. with a triac output rated at 600 V, the E43-1 designed for d.c. switching current of 500 mA at 60 V and E43-2 designed for 200 mA current switching at 250 V d.c.

*Norbain Electro Optics Limited  
Norbain House,  
Boulton Road,  
Reading,  
Berkshire RG2 0LT.  
Telephone: 0734 864411*

(2961 M)

## Capacitor and coil tester

Fieldtech Heathrow has recently introduced to the U.K. market a capacitor and inductance tester which is generating much interest in the electronics industry. Designated the LC53 the unit provides the engineer with a range of test functions never previously available in one unit. The unit is claimed to be unique because it is the only tester on the market which will dynamically test capacitors, coils, SCRs and TRIACs and will find an amazing 75% of defective capacitors which value-only meters will miss.

The unit, which is fast with 100% automatic ranging, tests capacitors for leakage current under full load, with up to 600 volts applied. It checks capacitor dielectric absorption, and has the capability to reform electrolytics. It will check for all coil defects in or out of circuit, it automatically tests coils for effective Q

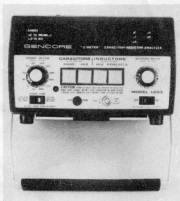

using a U.S. patented ringing test. It tests transmission lines for distance to open or short circuits within feet and it will also test dielectric strength to 600 volts. It may also be used for high potential leakage tests up to 600 volts. The unit is already being successfully used in major electronics companies giving broadcast, T.V., and video engineers quick reliable results with a unique range of test functions.

*Fieldtech Heathrow Limited,  
Huntavia House,  
420 Bath Road,  
Longford,  
Middlesex UB7 0LL.  
Telephone: 01 897 6446*

(2963 M)

## World's smallest lithium battery

Matsushita Electric Industrial Company Limited of Osaka, Japan, parent company of Panasonic U.K. Limited, announces the introduction of the world's smallest pin-type lithium battery. The 3 volt battery measures a mere 2.2 mm in diameter and 11 mm in length and initially will be marketed for use in ultra-small fishing floats with LED for night time fishing. The battery is expected to be widely adapted for use in small electronic

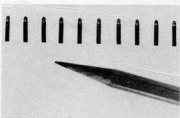

products - wrist watches, calculators, memory cards, memory back-ups, microphones, hearing aids and toys.

Due to the rapid gains in IC, LSI and VLSI technology the trend has been towards miniaturization in electronic equipment, therefore small high performance batteries have been in strong demand. The new battery has been developed through use of the maker's precision production technology and accumulated technological expertise in the field of

poly-carbon monofluoride lithium batteries. To achieve mass production of the 2.2 mm battery, dimension tolerance had to be decreased to one-tenth of previous models, in the drawing process of the aluminium case and in the areas of plastic moulding technology, seal packing and assembling technology of the battery.

### Features:

- Requires little space in a product;
- keeps constant operating voltage when charged,
- maintains long shelf life,
- three-volt battery is twice the voltage of silver-oxide and mercury batteries,
- capable of lighting LED,
- superior temperature characteristics.

*Panasonic U.K. Limited,  
300/318 Bath Road,  
Slough,  
Berkshire SL1 6JB.  
Telephone: 0753 34522.*

(2970 M)

## DIP diode networks

Iskra has introduced a new range of DIP diode networks, the BD series. Developed for logic circuit and similar applications requiring densely packed arrays of diodes or zeners, each network contains eight diodes mounted in a 16-pin plastic DIP measuring 21.5 mm x 8.5 mm x 4.6 mm tall (excluding pins). Pin spacing is the standard dual-in-line pitch of 0.100" and effective pin length is 3.2 mm. Diode types to be offered in this package are, initially, the 1N4148 100 V, 75 mA

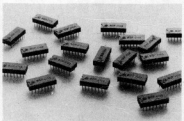

silicon planar epitaxial signal diode and the BZY 88C 4V7 4.7 volt zener but the manufacturer will shortly be offering a complete range of diodes in the DIP package including rectifier, fast recovery and zener types.

The packages, which are encapsulated in 'Cristin' 5K 615 FR flame retardant epoxy resin, are straightforward arrays, each diode being terminated separately with anodes brought out to pins on one side of the DIP and cathodes brought out on the other side. The new packages offer the circuit designer advantages in component packing density, in production costs and in handling and storage. Additionally, combinations of arrays of diodes, resistors and links can be supplied in the same packages.

*Iskra Limited,  
Redlands,  
Coulson,  
Surrey CR3 2HT.  
Telephone: 01 668 7141.*

(2972 M)

## Multimeter incorporates frequency meter

The model 1504 from Thurlby Electronics is a bench DMM which offers the bonus of a built-in frequency meter. Frequencies up to 3,999.9 kHz can be measured directly with a resolution of 100 Hz. A high accuracy figure of  $\pm 0.0025\%$  over 10-30°C is guaranteed by the 6 MHz crystal timebase. Sensitivity is typically 30 mV rms.

As a conventional multimeter it has a 4½ digit liquid crystal display extending to  $\pm 32,000$  counts. 32 ranges are provided enabling measurement of a.c. and d.c. voltage, resistance, diode test, and a.c. and d.c. current up to 25 amps. The meter has impressive sensitivity figures of 10  $\mu$ V, 10 m $\Omega$  and 1 nA as well as an excellent accuracy of 0.05%. All a.c. ranges are true RMS responding which enables accurate measurements to be made on non-sinusoidal waveforms, a feature essential for engineers who require power related measurements on switching waveforms.



The unit is housed in a newly designed high impact ABS case which incorporates a multi-position tilt-stand/handle. A carrying case is available for portable applications. The meter operates from internal batteries or from a.c. line power and weighs only 2½ lbs.

*Thurlby Electronics Ltd.*  
New Road,  
St. Ives,  
Huntingdon,  
Cambridgeshire PE17 4BG.  
Telephone: 0480 63570

(2957 M)

## The 'Stringy Floppy'

Astec Europe Ltd has introduced a new concept in data storage, the 'Stringy Floppy', which combines the low cost of a simple cassette with the fast access time of a floppy disk. The wafer cassette measures approximately 6.5 cm x 4 cm and can store up to 13 K bytes of formatted data on a 50 foot endless loop of tape. The data is recorded at a tape speed of 10 IPS at a rate of 21 K bps. A high speed mode allows any data to be found within a maximum of 35 seconds and the cassette has been optimised for precision tape tracking at high speeds. An 'intelligent controller' with a serial port provides a high-level command structure and a flexible file management system.

The data is stored in a disk-like block structure to allow maximum utilisation of the tape. Since the data format on the tape is standard, data interchangeability across different systems will be assured

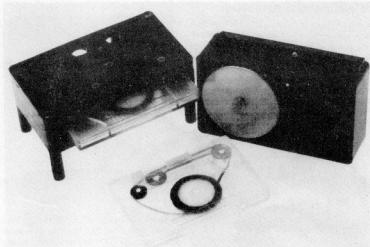

even if the interfaces run at different speeds. It is ideal for any computer with an RS232 port.

The 'Stringy Floppy' will be available in various forms: - a basic transport mechanism with read/write and motor control circuit; a basic transport mechanism with read/write, motor control circuits and an intelligent controller capable of serving two transports; a completely freestanding unit packaged to include drive mechanism, read/write, motor control logic, RS232 interface, PSU, integrating software and all associated cabling. Astec's research and development division is already working on variants of the device with storage capacities of 256 K/bytes per 50 feet of tape. Eventually it is anticipated that capacities in excess of 1 megabyte will be obtained using dual track heads.

*Astec Europe Ltd.*  
Telephone: 0734 509411. (2971 M)

## Copperfoil tape

Cost savings of 90% over the cost of printed circuit boards can be achieved using a novel tape produced by Copperfoil Enterprises. It is produced from 99.999 fine copper. Tested and approved at 24 V, 5 A d.c. and conforming to BS safety

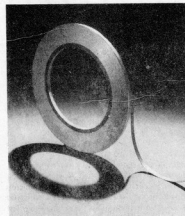

regulations, it is supplied backed with a high-temperature resistant adhesive which bonds monolithically to all insulating surfaces including plastic and paper. It solders simply without loss of integrity. Copperfoil is used for circuit tracks, burglar alarm systems, proximity switches, moisture detection, bus bars and other electronic applications. It is of particular value in the repair of printed circuit boards and for production of prototype boards. Widths available are 4, 4.75, 6, and 8 mm in 30 m rolls.

*Copperfoil Enterprises,*  
141 Lyndhurst Drive,  
Hornchurch,  
Essex RM11 1JP.  
Telephone: 040 24 56697 (2960 M)

## New extraction tool

A new extraction tool - the Model 507M from EREM - for extracting 14, 16 and 20 pin DIPs from printed circuit boards, is now available from UK distributor Nietronix Ltd. The 507M extracts the DIPs without damaging the components and extraction can be done within close proximity of

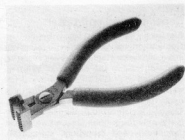

other components. The flat, steel head is shaped so that tracks on the circuit board cannot be scratched or damaged.

*Nietronix Limited*  
Smith's Forge,  
North End Road,  
Yatton,  
Avon BS19 4AU.  
Telephone: 0934 838656 (2969 M)

# SERVICES TO READERS

## EPS print service

Many of our circuits are accompanied by printed circuit designs. Some of these designs, but not all, are also available as ready-etched and pre-drilled boards, which can be ordered from our office. A complete list of the available boards is published under the heading 'EPS print service' in every issue. Delivery time is approximately three weeks.

It should be noted however that only boards which have at some time been published in the EPS list are available; the fact that a design for a board is published in a particular article does not necessarily imply that it can be supplied by Elektor.

## Technical queries

Please enclose a stamped, self-addressed envelope;

Letters should be addressed to the department concerned - TQE (Technical Queries). Although we feel that this is an essential service to readers, we regret that certain restrictions are necessary:

1. Questions that are not related to articles published in Elektor india cannot be answered.
2. Questions concerning the connection of our designs to other units (e.g. existing equipment) cannot normally be answered. An answer can only be based on a comparison of our design specifications with those of the other equipment.
3. Questions about suppliers for components are usually answered on the basis of advertisements, and readers can usually check these themselves.
4. As far as possible, answers will be on standard reply forms.

We trust that our readers will understand the reasons for these restrictions. On the one hand we feel that all technical queries should be answered as quickly and completely as possible; on the other hand this must not lead to overloading of our technical staff as this could lead to blown fuses and reduced quality in future issues.

## INTIMATE FRIENDS OF AN ELECTRONIC ENGINEER

Diamond  
DESOLDERING  
PUMP

ADHESIVE

Thresal

ANTISTATIC  
GUARANTEED  
SWIFT SUCTION  
ELEGANT FINISH  
ATTRACTIVE PACKING  
LARGEST SELLING  
WIDELY ACCEPTED  
NO COMPARISON  
DESOLDERING PUMP

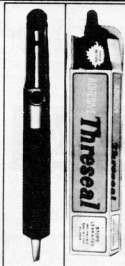

TRUSTED ADHESIVE  
FOR COUNTLESS  
APPLICATIONS IN  
ELECTRONIC,  
INSTRUMENTATION  
INDUSTRIES,  
REPAIRS SHOPS,  
RESEARCH LABS AND  
TECHNICAL INSTITUTES.

RENDERS THE FIXTURES  
VIBRATION PROOF

AVAILABLE IN  
TUBES, TINS & DRUMS

### DISTRIBUTORS

PRECIOUS ELECTRONICS CORPORATION  
3 CHUNAM LANE, LAMBTON ROAD, BOMBAY 400 007.  
PHONE: 387458, 388478 GRAM: DEEPTILAMP (GIRGAON BOMBAY)  
9 ATHPATTAN STREET, MOUNT ROAD, MADRAS 600 002.  
PHONE: 842718 GRAM: DEEPTILAMP (MADRAS 600 002)

GRACE/1871

## VASAVI's VLCR7 SAVES YOU FROM AGONY OF BRIDGES.



### FEATURES:

- Digital, Direct reading  
Non-inductive bridge balancing
- Simultaneous display of  
TAN DELTA (Loss factor)
- Widest possible range  
0.1 pF (at 10 ohm) to 0.001 ohm  
to 20,000  $\mu$  of 200H/20 M ohm
- BIAS terminal provision  
Also tests junction capacitance  
with bias.
- 4 Terminal measurement  
without wire-to-low resistance  
with high impedance measurements  
with wire-to-p.c.b.
- GUARD terminal provision  
without which low capacitance  
and high inductance measurements  
are meaningless  
with guard provision you can use long  
cables for measurements.
- MODULAR Construction  
for easy maintenance  
and so, long life.

M/s. VASAVI ELECTRONICS  
182, Vasavi Nagar,  
SECUNDERABAD-500 003.  
Ph. 70995 Grams: VELSCOPE



# Dependable, Versatile and carefully engineered Oscilloscopes 3030 and 3131 from Aplab

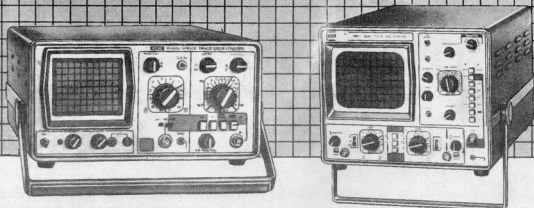

**Improved designs with maximum performance  
at minimum cost**

Aplab is the largest Indian manufacturer and exporter of worldclass Oscilloscopes.

**NOW AVAILABLE EX-STOCK**

#### Aplab 3030

- 15 MHz compact single trace oscilloscope
- DC-15 MHz bandwidth
- 5mV/div. sensitivity
- Built-in component tester
- One x 10 probe free

#### Aplab 3131

- 15 MHz dual trace triggered oscilloscope
- DC-15 MHz bandwidth
- 5mV/div. sensitivity on both channels
- Built-in component tester
- Two x 10 probes free

Other models available at short deliveries

- 3033-15MHz, Battery operated
- 3034-15MHz, Dual, Battery operated
- 3035-10MHz, Wide screen
- 3337-30MHz, Dual
- 3339-30MHz, Dual, VDU scope
- 3536-50MHz, Delayed sweep, Dual
- 3537-50MHz, Dual
- 3538-50MHz, Dual Storage scope.

## Applied Electronics Limited

Aplab House, A-5 Wagle Industrial Estate, Thane 400 604. Phone: 591861 (3 lines) Telex: 011-71979 APEL IN.  
8/A Gandhi Nagar, Secunderabad 500 003. Phone: 73351.  
22C, Manohar Pukur Road, Calcutta 700 029.

Nos. 44 & 45 Residency Road, Bangalore 560 025. Phone: 578977 Telex: 0845-8125 APLB IN.  
MF-3 Stutee Building, Bank Street, Karol Bagh, New Delhi 110 005. Phone: 578842 Telex: 031-5133 APLB IN

# Aplab — Leadership through technology

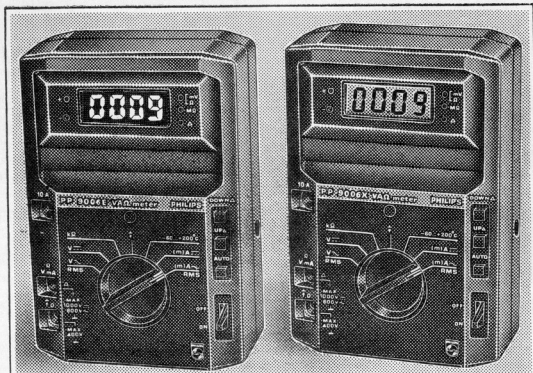

**Philips PP 9006 E/X Digital Multimeter**  
 Incredible performance at a believable price!  
 Full 4 digit display for extreme accuracy  
 and precision.

Philips PP 9006 E/X with very wide voltage and current ranges offers full 4 digit resolution and accuracy. True rms measurements enables AC signals to be measured independently of wave form and distortion. An optional probe can be added on, to measure temperatures.

PP 9006 E/X, a no-compromise 4 digit multimeter with the proven convenience of autoranging. Small and sturdy and, built to international standards.

Another advanced Philips Multimeter:  
 PM 2502 - General Purpose Multimeter

For further details contact:  
**Philips India**  
 Plot 80, Bhosari Industrial Estate  
 Pune 411 026



**Test & Measuring  
 Instruments**

**PHILIPS**

*Philips - the trusted Indian household name for over fifty years*

OBM/1324

## CONDITIONS OF ACCEPTANCE OF CLASSIFIED ADVERTISEMENTS

1) Advertisements are accepted subject to the conditions appearing on our current rate card and on the express understanding that the Advertiser warrants that the advertisement does not contravene any trade act in force in the country.

2) The Publishers reserve the right to refuse or withdraw any advertisement.

3) Although every care is taken, the Publishers shall not be liable for clerical or printer's errors or their consequences.

4) The Advertiser's full name and address must accompany each advertisement submitted.

The prepaid rate for classified advertisement is Rs. 2.00 per word (minimum 24 words).  
Semi Display panels of 3 cms by 1 column. Rs. 150.00 per panel. All cheques, money orders, etc. to be made payable to Elektor Electronics Pvt. Ltd. Advertisements, together with remittance, should be sent to The Classified Advertisement Manager. For outstation cheques please add Rs. 2.50

Electronics Tools like Soldering Irons, Pliers, Cutters, Screw Drivers, Tweezers at Competitive Prices. Contact Aradhna Electronics (P) Ltd., 10, Srinath Complex, Sarojinidevi Road, Secunderabad 500 003.

Telephony Intel Continental requires distributors/dealers for: Telephone S.T.D. Locks, Digital Wall/Table/Car Clocks, Insect Killer, Bank Token Indicators, L.E.Ds. Chairing : 39, Sangram Colony, Mahavir Marg, Jaipur.

AVAILABLE KNOWHOW FOR ELECTRO-MAGNETIC RELAYS. REPLY P.K. PILLAI, FLAT NO. 12, IDEAL HOUSE 156, SION EAST, BOMBAY 400 022.

## missing link

### analytical video display

(June 1984, page 5-31)

We regret that line-15 has

fallen out of Table 2 on

page 5-35; this line reads:

15 10101 15 0 1 0 1 0 0 0 1 51 blue

Also, the end of line -14

should read:

5 B blue

APLAB .....	7.71
ARUN ELECTRONICS .....	7.08
CALOMIX .....	7.06
COMPONENT TECHNIQUE .....	7.12
COSMIC .....	7.76
DOMINION RADIOS .....	7.67
ELECTRICAL INSTRUMENT CO .....	7.14
ELCOT .....	7.13
ELMATRONICS .....	7.09
GENERAL SALES AGENCY .....	7.67
IEAP .....	7.65
INSTRUMENT RESEARCH ASSOCIATES .....	7.05
INDUSTRIAL RADIO HOUSE .....	7.14
IZUMIYA .....	7.14
J. M. ENTERPRISES .....	7.07
LUXCO .....	7.66
MFR .....	7.11
PHILIPS .....	7.73
RUTTONSHA .....	7.08
SATO .....	7.06
TECHNICAL TRADE LINKS .....	7.06
TESTICA .....	7.67
UPTRON .....	7.08
VASAVI .....	7.65
VISHA .....	7.12
ZODIAC .....	7.12

next month

Our Bumper Double Issue

THE AUGUST/SEPTEMBER 1984

ANNUAL CIRCUITS SPECIAL

OVER HUNDRED EXCITING CIRCUITS

Book Your Copy Now  
With Your Local Newsagent

**NOT TO BE MISSED...**

# pro power COSMIC

Choice of  
**30 Watts to  
600 Watts**

HI FI INTEGRATED  
STEREO AMPLIFIERS

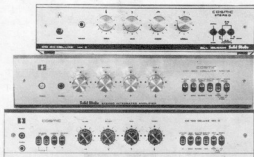

CO 40 DELUX MK II  
40 Watts \* 0.5%

CO 60 DELUX MK II  
60 Watts \* 0.5%

CO 100 DELUX MK II  
100 Watts \* 0.5%

MINI  
SERIES



MINI LAB 150  
180 Watts \* Less than 0.08%

## LAB SERIES — Panorama Control

LAB 3000 MK II  
200 Watts  
\* Less than 0.05%

LAB 5000 MK II  
300 Watts  
\* Less than 0.05%

LAB 6 x 1000  
600 Watts  
\* Less than 0.01%

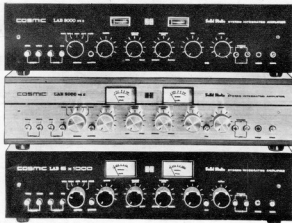

\* Harmonic Distortion at  
Rated output at 1 KHz

Cosmic amplifiers are masterpieces of technological sophistication, giving true fidelity and perfect clarity of output. Cosmic pro power amplifiers are available in a range from 30 watts total output to 600 watts total output.

Select from the widest range of amplifiers in India, matched with appropriate speakers, and play your kind of music on turntables and tape decks - all by Cosmic, the pioneers in stereo systems in India, with over a quarter century of experience in manufacturing and marketing quality sound equipment.

International quality created for India by **COSMIC**